



Cap Assembly Insert
HTFS0304-C



C-01

Bulkhead Lock Nut
HTFS0306



C-02

Tube Nut
HTFS0318



C-03

Tube Sleeve
HTFS0319

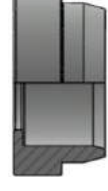

C-04

Bore-MFS Straight
HTFS0403

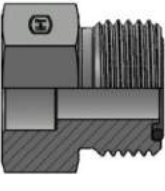

C-05

Bore-MFS Bulkhead
HTFS0406

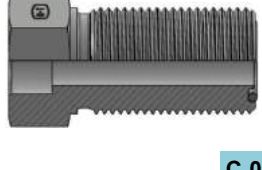

C-06

MFS-MFS Straight
HTFS2403

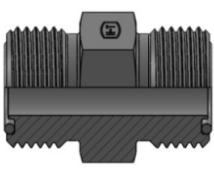

C-07

MFS-MP Straight
HTFS2404

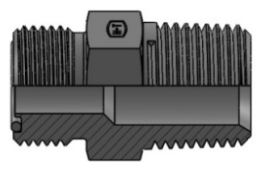

C-08

MFS-FP Straight
HTFS2405

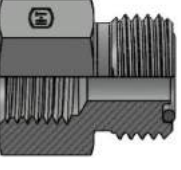

C-09

FFS-MFS Tube End Reducer
HTFS2406

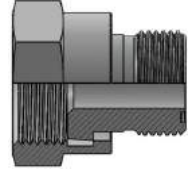

C-10

MFS Plug
HTFS2408

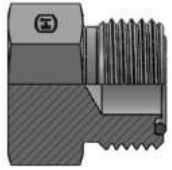

C-11

MFS-MFS 90° Elbow
HTFS2500



C12

MFS-MP 90° Elbow
HTFS2501



C-13

MFS-MP 45° Elbow
HTFS2503

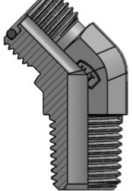

C-14

MFS-MFS-MP Tee
HTFS2601

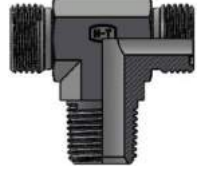

C-15

MFS-MFS-MFS Tee
HTFS2603

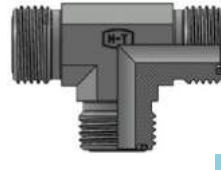

C-16

MFS-MP-MFS Tee
HTFS2605

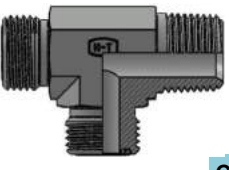

C-17

MFS-MFS-MFS-MFS Cross
HTFS2650



C-18

MFS-MFS Bulkhead Union
HTFS2700

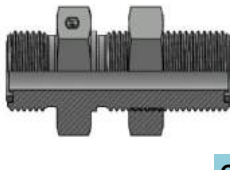

C-19

MFS-MFS Bulkhead 90°
HTFS2701

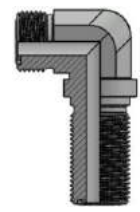

C-20

ORFS FITTING

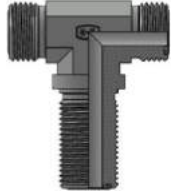
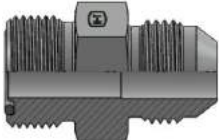
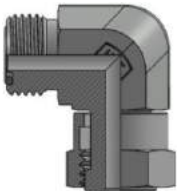
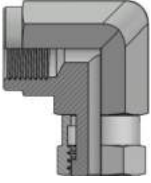
<p>MFS-MFS Bulkhead 45° HTFS2702</p>  <p>C-21</p>	<p>MFS-MFS-MFS Bulkhead Tee HTFS2703</p>  <p>C-22</p>	<p>MFS-MFS-MFS Bulkhead Tee HTFS2704</p>  <p>C-23</p>	<p>MFS-MORB Bulkhead Straight HTFS2764</p>  <p>C-24</p>
<p>MFS-MORB Straight HTFS6400-O</p>  <p>C-25</p>	<p>MFS-MORB Straight Long HTFS6400-L-O</p>  <p>C-26</p>	<p>MFS-FJS Straight HTFS6402</p>  <p>C-27</p>	<p>MFS-MJ Straight HTFS6403</p>  <p>C-28</p>
<p>FORB-MFS Straight HTFS6410</p>  <p>C-29</p>	<p>MFS-FFSS 90° HTFS6500</p>  <p>C-30</p>	<p>MFS-FFSS 45° HTFS6502</p>  <p>C-31</p>	<p>FP-FFSS 90° HTFS6503</p>  <p>C-32</p>
<p>FFSS-MJ Straight HTFS6504</p>  <p>C-33</p>	<p>MP-FFSS Straight HTFS6505</p>  <p>C-34</p>	<p>FFSS-MORB Straight HTFS6540</p>  <p>C-35</p>	<p>FFSS-FFSS Straight HTFS6565</p>  <p>C-36</p>
<p>MFS-MFS-FFSS Branch Tee HTFS6600</p>  <p>C-37</p>	<p>MFS-FFSS-MFS Run Tee HTFS6602</p>  <p>C-38</p>	<p>MFS-MAORB 90° Elbow HTFS6801-NWO</p>  <p>C-39</p>	<p>MFS-MAORB 90° Long Elbow HTFS6801-L-NWO</p>  <p>C-40</p>

Continued.....

ORFS FITTING

MFS-MAORB 90° X-Long
HTFS6801-LL-NWO

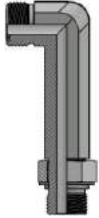

C-41

MFS-MAORB 45° Elbow
HTFS6802-NWO



C-42

MFS--MFS-MAORB Tee
HTFS6803-NWO



C-43

MFS-MAORB-MFS Tee
HTFS6804-NWO



C-44

FFSS-MAORB-MFS 90° Elbow
HTFS6809-NWO



C-45

MFS-MABSPP 90° Elbow
HTFS7202-NWO



C-46

MFS-MMAORB 90° Elbow
HTFS7205-NWO



C-47

MFS-MFS-MMAORB Tee
HTFS7210-NWO



C-48

MFS-MMAORB-MFS Tee
HTFS7215-NWO



C-49

MFS-MMAORB 45° Elbow
HTFS7300-NWO



C-50

MFS-MMORB Straight
HTFS7640-O

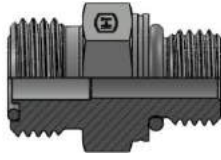

C-51

MFS-MMED Straight
HTFS7701

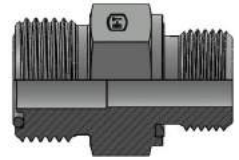

C-52

MFS-MBSPPED Straight
HTFS7709

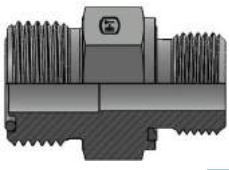

C-53

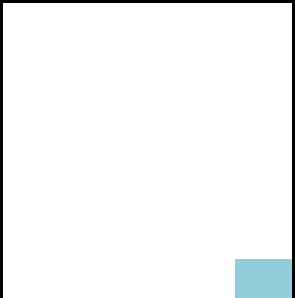
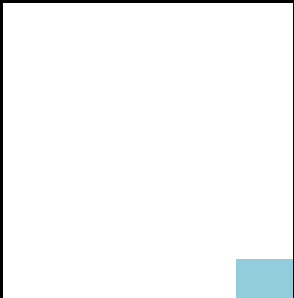
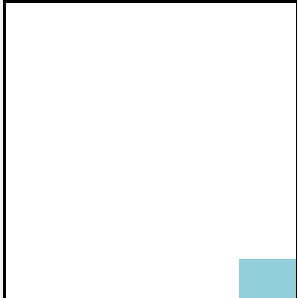
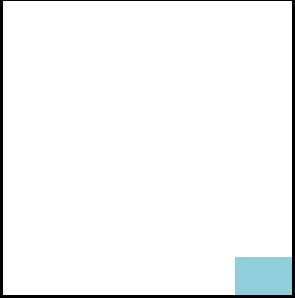
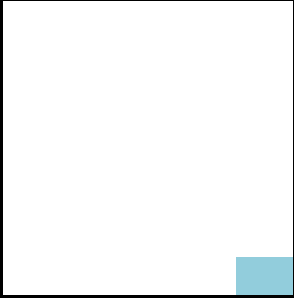

Thread Charts • JIC – SAE • Metric/International																
Dash Size	02	03	04	05	06	07	08	10	12	14	16	20	24	32	40	48
Tube O.D.	1/8	3/16	1/4	5/16	3/8	7/16	1/2	5/8	3/4	7/8	1	1¼	1½	2	2½	3
Hose I.D.	1/8	3/16	1/4	5/16	3/8		1/2	5/8	3/4		1	1¼	1½	2	2½	3
JIC 37-Flare Thread	5/16 - 24	3/8 - 24	7/16 - 20	1/2 - 20	9/16 - 18		3/4 - 16	7/8 - 14	11/16 - 12	13/16 - 12	15/16 - 12	15/8 - 12	17/8 - 12	2½ - 12	3 - 12	3½ - 12
SAE O-Ring Thread	5/16 - 24	3/8 - 24	7/16 - 20	1/2 - 20	9/16 - 18		3/4 - 16	7/8 - 14	11/16 - 12	13/16 - 12	15/16 - 12	15/8 - 12	17/8 - 12	2½ - 12		
NPTF Pipe Thread	1/8 - 27		1/4 - 18		3/8 - 18		1/2 - 14		3/4 - 14		1 - 11½	1¼ - 11½	1½ - 11½	2 - 11½	2½ - 8	3-8
NPSM Swivel Thread	1/8 - 27		1/4 - 18		3/8 - 18		1/2 - 14		3/4 - 14		1 - 11½	1¼ - 11½	1½ - 11½	2 - 11½		
Flat Face Thread			9/16 - 18		11/16 - 16		13/16 - 16	1 - 14	13/18 - 12		17/16 - 12	111/16 - 12	2 - 12			
Code 61 Flange Head O.D.							1.19		1.50		1.75	2.00	2.38	2.81	3.31	4.00
Code 62 Flange Head O.D.							1.25		1.62		1.88	2.12	2.50	3.12		
British Thread BSPP/BSPT	1/8 - 28		1/4 - 19		3/8 - 19		1/2 - 14		3/4 - 14		1 - 11	1¼ - 11	1½ - 11			
Brake Thread			7/16 - 24		17/32 - 24		11/16 - 20	13/16 - 18	1 - 18							
SAE 45-Flare Thread	5/16 - 24	3/8 - 24	7/16 - 20	1/2 - 20	5/8 - 18	11/16 - 24	3/4 - 16	7/8 - 14	11/16 - 14							
Inverted Flare Thread	5/16 - 28	3/8 - 24	7/16 - 24	1/2 - 20	5/8 - 18	11/16 - 18	3/4 - 18	7/8 - 18	11/16 - 16							
Compression Thread	5/16 - 24	3/8 - 24	7/16 - 20	1/2 - 20	9/16 - 18	3/4 - 16	1 - 11	15/16 - 12	15/16 - 12	17/8 - 12	2½ - 12					
Metric Thread	M10	M12	M14	M16	M18	M20	M22	M24	M26	M27	M30	M33	M36	M42	M48	
	M 10x1.0	M 12x1.5	M 14x1.5	M 16x1.5	M 18x1.5	M 20x1.5	M 22x1.5	M 24x1.5	M 26x1.5	M 27x2.0	M 30x2.0	M 33x2.0	M 36x2.0	M 42x2.0	M 48x2.0	

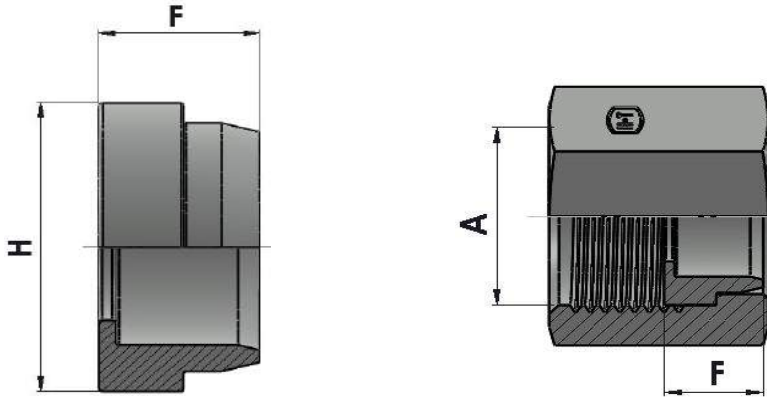

XXHTFS0319-00 Series

Sleeve

Tube O.D.	H O.D.	F Length	A THREAD	Part Number	Weight	Torque N-m	Working pressure in Bar
1/4"	12.75	9.5	9/16"-18	HTFS0319-04	0.006	14-16	413
3/8"	15.75	9.5	11/16"-18	HTFS0319-06	0.009	24-27	413
1/2"	18.92	9.5	13/16"-16	HTFS0319-08	0.013	43-47	413
5/8"	23.44	10.5	1"-14	HTFS0319-10	0.021	60-68	413
3/4"	27.86	14	1-3/16"-12	HTFS0319-12	0.040	90-95	413
1"	34.21	15.5	1-7/16"-12	HTFS0319-16	0.067	125-135	413
1-1/4"	40.56	15.5	1-11/16"-12	HTFS0319-20	0.094	170-190	275
1-1/2"	48.51	15.5	2"-12	HTFS0319-24	0.135	200-225	275

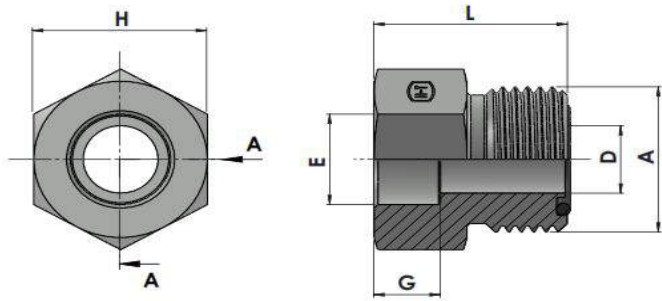

XXHTFS0403-00-00 Series
Bore-MFS Straight

Tube O.D.	A THREAD	H Hex	L	D	E	G	Part Number	Weight	Torque N-m	Working pressure in Bar
1/4"	9/16"-18	15.88	22.00	4.40	6.50	8.50	HTFS0403-04-04	0.023	14-16	413
3/8"	11/16"-18	19.05	23.10	6.70	9.68	8.50	HTFS0403-06-06	0.034	24-27	413
1/2"	13/16"-16	22.22	24.70	9.60	12.85	8.50	HTFS0403-08-08	0.050	43-47	413
5/8"	1"-14	26.99	27.40	12.30	16.03	8.50	HTFS0403-10-10	0.081	60-68	413
3/4"	1-3/16"-12	31.75	33.70	15.50	19.23	12.50	HTFS0403-12-12	0.138	90-95	413
1"	1-7/16"-12	38.10	38.60	20.60	25.58	14.00	HTFS0403-16-16	0.228	125-135	413
1-1/4"	1-11/16"-12	44.45	38.60	26.00	31.95	14.00	HTFS0403-20-20	0.311	170-190	275
1-1/2"	2"-12	53.98	38.60	32.00	38.30	14.00	HTFS0403-24-24	0.458	200-225	275

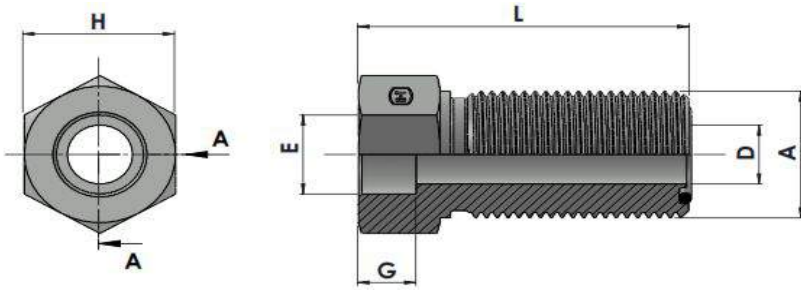

XXHTFS0406-00-00 Series
Bore-MFS Straight Long

Tube O.D.	A THREAD	H Hex	L	D	E	G	Part Number	Weight	Torque N-m	Working pressure in Bar
1/2"	13/16"-16	22.22	48.51	9.60	12.85	8.50	HTFS0406-08-08	0.098	43-47	413
1/2"	13/16"-16	26.99	48.51	9.60	16.03	8.50	HTFS0406-10-08	0.144	43-47	413

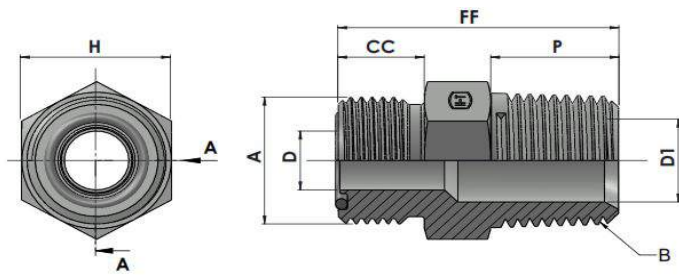

XXHTFS2404-00-00 Series
MFS-MP Straight

Tube O.D.	A THREAD	B THREAD	H Hex	FF	CC	P	D	D1	Part Number	Weight	Torque N-m	Working pressure in Bar
1/4"	9/16"-18	1/4"-18NPTF	15.88	32.00	9.80	14.20	4.40	5.60	HTFS2404-04-04	0.033	14-16	413
3/8"	11/16"-18	3/8"-18NPTF	19.05	34.00	11.20	14.20	6.70	8.40	HTFS2404-06-06	0.050	24-27	413
1/2"	13/16"-16	1/2"-14NPTF	22.22	41.66	12.80	19.00	9.60	11.90	HTFS2404-08-08	0.084	43-47	413
3/4"	1-3/16"-12	3/4"-14NPTF	31.75	49.28	17.00	19.00	15.50	16.50	HTFS2404-12-12	0.202	90-95	413
1"	1-7/16"-12	1"-11-1/2NPTF	38.10	55.63	17.50	23.90	20.60	21.10	HTFS2404-16-16	0.329	125-135	413
1-1/4"	1-11/16"-12	1-1/4"-11-1/2NPTF	44.45	58.42	17.50	24.60	26.00	28.40	HTFS2404-20-20	0.470	170-190	275
1-1/2"	2"-12	1-1/2"-11-1/2NPTF	53.98	60.96	17.50	25.40	32.00	34.50	HTFS2404-24-24	0.723	200-225	275

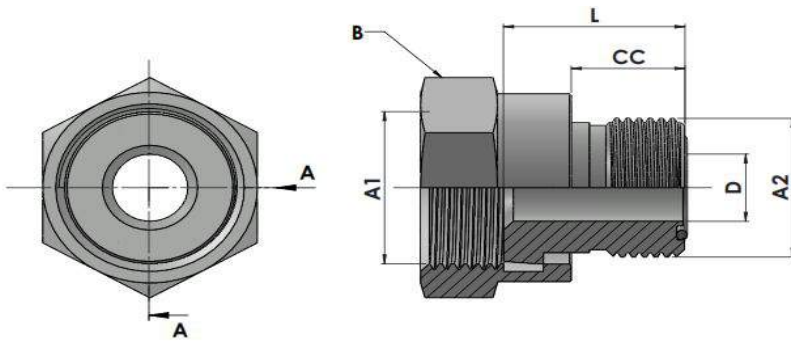

XXHTFS2406-00-00 Series
FFS-MFS Straight

A1 Tube O.D.	A2 Tube O.D.	A1 THREAD	A2 THREAD	L	CC	D	Part Number	Weight	Torque N-m	Working pressure in Bar
1/2"	1/4"	13/16"-16	9/16"-18	21.80	9.80	4.40	HTFS2406-08-04			
5/8"	1/4"	1"-14	9/16"-18	22.80	9.80	4.40	HTFS2406-10-04			
5/8"	3/8"	1"-14	11/16"-18	24.10	11.20	6.70	HTFS2406-10-06			
5/8"	1/2"	1"-14	13/16"-16	25.70	12.80	9.60	HTFS2406-10-08			
3/4"	1/4"	1-3/16"-12	9/16"-18	24.80	9.80	4.40	HTFS2406-12-04			
3/4"	3/8"	1-3/16"-12	11/16"-18	26.20	11.20	6.70	HTFS2406-12-06			
3/4"	1/2"	1-3/16"-12	13/16"-16	27.70	12.80	9.60	HTFS2406-12-08			
1"	1/2"	1-7/16"-12	13/16"-16	29.20	12.80	9.60	HTFS2406-16-08			
1"	5/8"	1-7/16"-12	1"-14	32.00	15.50	12.30	HTFS2406-16-10			
1-1/4"	3/4"	1-11/16"-12	1-3/16"-12	33.50	17.00	15.50	HTFS2406-20-12			
1-1/2"	1"	2"-12	1-7/16"-12	34.00	17.50	20.60	HTFS2406-24-16			
1-1/2"	1-1/4"	2"-12	1-11/16"-12	34.00	17.50	26.00	HTFS2406-24-20			

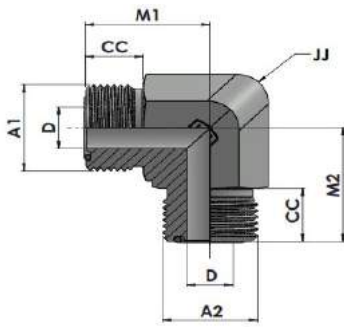

XXHTFS2500-00-00 Series
MFS-MFS 90° ELBOW

Tube O.D.	A1 THREAD	A2 THREAD	D DRILL	M1 LENGTH	M2 LENGTH	CC LENGTH	JJ Hex	Part Number	Weight	Torque N-m	Working pressure in Bar
1/4"	9/16"-18	9/16"-18	4.40	21.50	21.50	9.80	14.29	HTFS2500-04-04		14-16	413
3/8"	11/16"-18	11/16"-18	6.70	25.00	25.00	11.20	19.05	HTFS2500-06-06		24-27	413
1/2"	13/16"-16	13/16"-16	9.60	28.00	28.00	12.80	19.05	HTFS2500-08-08		43-47	413
5/8"	1"-14	1"-14	12.30	33.30	33.30	15.50	26.99	HTFS2500-10-10		60-68	413
3/4"	1-3/16"-12	1-3/16"-12	15.50	37.30	37.30	17.00	30.16	HTFS2500-12-12		90-95	413
1"	1-7/16"-12	1-7/16"-12	20.60	41.70	41.70	17.50	36.51	HTFS2500-16-16		125-135	413
1-1/4"	1-11/16"-12	1-11/16"-12	26.00	44.70	44.70	17.50	41.28	HTFS2500-20-20		170-190	275
1-1/2"	2"-12	2"-12	32.00	48.80	48.80	17.50	47.62	HTFS2500-24-24		200-225	275

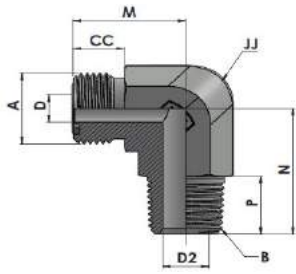

XXHTFS2501-00-00 Series
MFS-MP 90° ELBOW

Tube O.D.	A THREAD	B THREAD	D DRILL	D 2 DRILL	M LENGTH	N LENGTH	P LENGTH	CC LENGTH	JJ Hex	Part Number	Weight	Torque N-m	Working pressure in Bar
1/4"	9/16"-18	1/4"-18NPTF	4.40	7.00	21.50	27.70	14.20	9.80	14.29	HTFS2501-04-04		14-16	413
3/8"	11/16"-18	3/8"-18NPTF	6.70	10.30	25.00	31.00	14.20	11.20	19.05	HTFS2501-06-06		24-27	413
1/2"	13/16"-16	1/2"-14NPTF	9.60	13.50	28.00	33.30	19.00	12.80	19.05	HTFS2501-08-08		43-47	413
1"	1-7/16"-12	1"-11-1/2"NPTF	20.60	23.80	41.70	50.00	19.00	17.50	36.51	HTFS2501-16-16		125-135	413
1-1/4"	1-11/16"-12	1-1/4"-11-1/2"NPTF	26.00	31.80	44.70	60.50	23.90	17.50	41.28	HTFS2501-20-20		170-190	275
1-1/2"	2"-12	1-1/2"-11-1/2"NPTF	32.00	38.00	48.80	67.00	24.60	17.50	47.62	HTFS2501-24-24		200-225	275

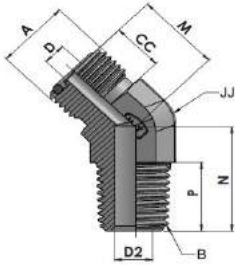

**XXHTFS2503-00-00 Series
MFS-MP 45° ELBOW**

Tube O.D.	A THREAD	B THREAD	D DRILL	D 2 DRILL	M LENGTH	N LENGTH	P LENGTH	CC LENGTH	JJ Hex	Part Number	Weight	Torque N-m	Working pressure in Bar
1/4"	9/16"-18	1/4"-18NPTF	4.40	7.00	16.00	21.80	14.20	9.80	14.29	HTFS2503-04-04		14-16	413
3/8"	11/16"-18	3/8"-18NPTF	6.70	10.30	18.80	24.10	14.20	11.20	19.05	HTFS2503-06-06		24-27	413
1/2"	13/16"-16	1/2"-14NPTF	9.60	13.50	20.30	29.70	19.00	12.80	19.05	HTFS2503-08-08		43-47	413
1"	1-7/16"-12	1"-11-1/2"NPTF	20.60	23.80	30.00	37.60	19.00	17.50	36.51	HTFS2503-16-16		125-135	413
1-1/4"	1-11/16"-12	1-1/4"-11-1/2"NPTF	26.00	31.80	32.00	42.40	23.90	17.50	41.28	HTFS2503-20-20		170-190	275
1-1/2"	2"-12	1-1/2"-11-1/2"NPTF	32.00	38.00	36.80	58.70	24.60	17.50	47.62	HTFS2503-24-24		200-225	275

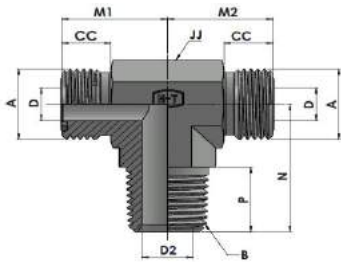

XXHTFS2601-00-00-00 Series

MFS-MFS-MP TEE

Tube O.D.	A THREAD	B THREAD	D DRILL	D2 DRILL	M1 LENGTH	M2 LENGTH	N LENGTH	P LENGTH	CC LENGTH	JJ Hex	Part Number	Weight	Torque N-m	Working pressure in Bar
1/4"	9/16"-18	1/4"-18NPTF	4.40	7.00	21.50	21.50	27.70	14.20	9.80	14.29	HTFS2601-04-04-04		14-16	413
3/8"	11/16"-18	3/8"-18NPTF	6.70	10.30	25.00	25.00	31.00	14.20	11.20	19.05	HTFS2601-06-06-06		24-27	413
1/2"	13/16"-16	1/2"-14NPTF	9.60	13.50	28.00	28.00	37.40	19.00	12.80	19.05	HTFS2601-08-08-08		43-47	413
3/4"	1-3/16"-12	3/4"-14NPTF	15.50	18.26	37.30	37.30	39.60	19.00	17.00	30.16	HTFS2601-12-12-12		90-95	413
1"	1-7/16"-12	1"-11-1/2"NPTF	20.60	23.80	41.70	41.70	40.40	23.90	17.50	36.51	HTFS2601-16-16-16		125-135	413
1-1/4"	1-11/16"-12	1-1/4"-11-1/2"NPTF	26.00	31.80	44.70	44.70	50.00	24.6	17.50	41.28	HTFS2601-20-20-20		170-190	275
1-1/2"	2"-12	1-1/2"-11-1/2"NPTF	32.00	38.00	48.80	48.80	58.70	25.40	17.50	47.62	HTFS2601-24-24-24		200-225	275

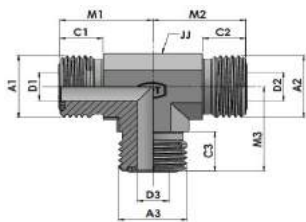

XXHTFS2603-00-00-00 Series

MFS-MFS-MFS TEE

Tube O.D.	A1 THREAD	A2 THREAD	A3 THREAD	M1 LENGTH	M2 LENGTH	M3 LENGTH	D1 DRILL	D2 DRILL	D3 DRILL	C1 LENGTH	C2 LENGTH	C3 LENGTH	JJ Hex	Part Number	Weight	Torque N-m	Working pressure in Bar
1/4"	9/16"-18	9/16"-18	9/16"-18	21.50	21.50	21.50	4.40	4.40	4.40	9.80	9.80	9.80	14.29	HTFS2603-04-04-04		14-16	413
3/8"	11/16"-18	11/16"-18	11/16"-18	25.00	25.00	25.00	6.70	6.70	6.70	11.20	11.20	11.20	19.05	HTFS2603-06-06-06		24-27	413
1/2"	13/16"-16	13/16"-16	13/16"-16	28.00	28.00	28.00	9.60	9.60	9.60	12.80	12.80	12.80	19.05	HTFS2603-08-08-08		43-47	413
5/8"	1"-14	1"-14	1"-14	33.30	33.30	33.30	12.30	12.30	12.30	15.50	15.50	15.50	26.99	HTFS2603-10-10-10		60-68	413
3/4"	1-3/16"-12	1-3/16"-12	1-3/16"-12	37.30	37.30	37.30	15.50	15.50	15.50	17.00	17.00	17.00	30.16	HTFS2603-12-12-12		90-95	413
1"	1-7/16"-12	1-7/16"-12	1-7/16"-12	41.70	41.70	41.70	20.60	20.60	20.60	17.50	17.50	17.50	36.51	HTFS2603-16-16-16		125-135	413
1-1/4"	1-11/16"-12	1-11/16"-12	1-11/16"-12	44.70	44.70	44.70	26.00	26.00	26.00	17.50	17.50	17.50	41.28	HTFS2603-20-20-20		170-190	275
1-1/2"	2"-12	2"-12	2"-12	48.80	48.80	48.80	32.00	32.00	32.00	17.50	17.50	17.50	47.62	HTFS2603-24-24-24		200-225	275

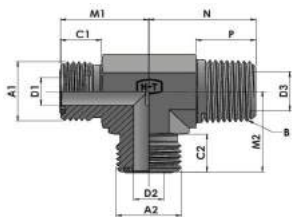

XXHTFS2605-00-00-00 Series

MFS-MP-MFS TEE

Tube O.D.	A 1 THREAD	A2 THREAD	B THREAD	M1 LENGTH	M2 LENGTH	N LENGTH	D1 DRILL	D2 DRILL	D3 DRILL	C1 LENGTH	C2 LENGTH	P LENGTH	JJ Hex	Part Number	Weight	Torque N-m	Working pressure in Bar
1/4"	9/16"-18	9/16"-18	1/4"-18NPTF	21.50	21.50	27.70	4.40	4.40	7.00	9.80	9.80	14.20	14.29	HTFS2605-04-04-04			
3/8"	11/16"-18	11/16"-18	3/8"-18NPTF	25.00	25.00	31.00	6.70	6.70	10.30	11.20	11.20	14.20	19.05	HTFS2605-06-06-06			
1/2"	13/16"-16	13/16"-16	1/2"-14NPTF	28.00	28.00	37.40	9.60	9.60	13.50	12.80	12.80	19.00	19.05	HTFS2605-08-08-08			
3/4"	1-3/16"-12	1-3/16"-12	3/4"-14NPTF	37.30	37.30	40.40	15.50	15.50	18.26	17.00	17.00	19.00	30.16	HTFS2605-12-12-12			
1"	1-7/16"-12	1-7/16"-12	1"-11-1/2"NPTI	41.70	41.70	50.00	20.60	20.60	23.80	17.50	17.50	23.90	36.51	HTFS2605-16-16-16			

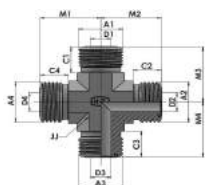

XXHTFS2650-00-00-00-00 Series

MFS-MFS-MFS-MFS CROSS

Tube O.D.	M1 LENGTH	M2 LENGTH	M3 LENGTH	M4 LENGTH	A1 THREAD	A2 THREAD	A3 THREAD	A4 THREAD	D1 DRILL	D2 DRILL	D3 DRILL	C1 LENGTH	C2 LENGTH	C3 LENGTH	C4 LENGTH	JJ Hex	Part Number	Weight	Torque N-m	Working pressure in Bar
1/4"	21.50	21.50	21.50	21.50	9/16"-18	9/16"-18	9/16"-18	9/16"-18	4.40	4.40	4.40	9.80	9.80	9.80	9.80	14.29	HTFS2650-04-04-04-04		14-16	413
3/8"	25.00	25.00	25.00	25.00	11/16"-18	11/16"-18	11/16"-18	11/16"-18	6.70	6.70	6.70	11.20	11.20	11.20	11.20	19.05	HTFS2650-06-06-06-06		24-27	413
1/2"	28.00	28.00	28.00	28.00	13/16"-16	13/16"-16	13/16"-16	13/16"-16	9.60	9.60	9.60	12.80	12.80	12.80	12.80	19.05	HTFS2650-08-08-08-08		43-47	413
5/8"	33.30	33.30	33.30	33.30	1"-14	1"-14	1"-14	1"-14	12.30	12.30	12.30	15.50	15.50	15.50	15.50	26.99	HTFS2650-10-10-10-10		60-68	413
3/4"	37.30	37.30	37.30	37.30	1-3/16"-12	1-3/16"-12	1-3/16"-12	1-3/16"-12	15.50	15.50	15.50	17.00	17.00	17.00	17.00	30.16	HTFS2650-12-12-12-12		90-95	413
1"	41.70	41.70	41.70	41.70	1-7/16"-12	1-7/16"-12	1-7/16"-12	1-7/16"-12	20.60	20.60	20.60	17.50	17.50	17.50	17.50	36.51	HTFS2650-16-16-16-16		125-135	413
1-1/4"	44.70	44.70	44.70	44.70	1-11/16"-12	1-11/16"-12	1-11/16"-12	1-11/16"-12	26.00	26.00	26.00	17.50	17.50	17.50	17.50	41.28	HTFS2650-20-20-20-20		170-190	275
1-1/2"	48.80	48.80	48.80	48.80	2"-12	2"-12	2"-12	2"-12	32.00	32.00	32.00	17.50	17.50	17.50	17.50	47.62	HTFS2650-24-24-24-24		200-225	275

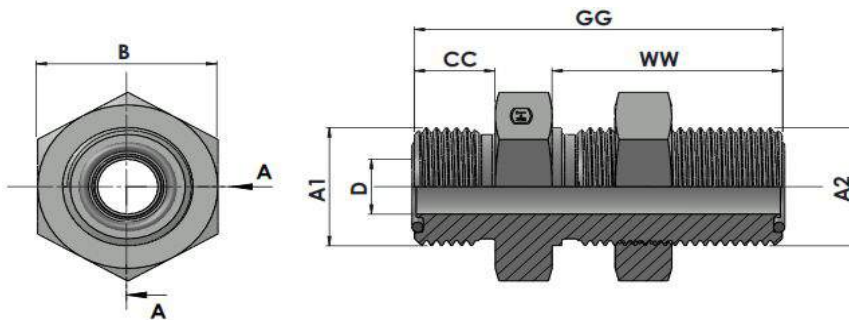

XXHTFS2700-00-00 Series
MFS-MFS BULKHEAD UNION

Tube O.D.	A1 THREAD	A2 THREAD	GG LENGTH	CC LENGTH	WW LENGTH	D DRILL	B Hex	Part Number	Weight	Torque N-m	Working pressure in Bar
1/4"	9/16"-18	9/16"-18	48.20	9.80	31.50	4.40	20.64	HTFS2700-04-04		14-16	413
3/8"	11/16"-18	11/16"-18	53.20	11.20	34.00	6.70	25.40	HTFS2700-06-06		24-27	413
1/2"	13/16"-16	13/16"-16	58.30	12.80	36.50	9.60	28.58	HTFS2700-08-08		43-47	413
5/8"	1"-14	1"-14	66.60	15.50	40.60	12.30	33.34	HTFS2700-10-10		60-68	413
3/4"	1-3/16"-12	1-3/16"-12	69.20	17.00	41.70	15.50	38.10	HTFS2700-12-12		90-95	413
1"	1-7/16"-12	1-7/16"-12	70.20	17.50	42.20	20.60	44.45	HTFS2700-16-16		125-135	413
1-1/4"	1-11/16"-12	1-11/16"-12	70.20	17.50	42.20	26.00	50.80	HTFS2700-20-20		170-190	275
1-1/2"	2"-12	2"-12	70.20	17.50	42.20	32.00	60.33	HTFS2700-24-24		200-225	275

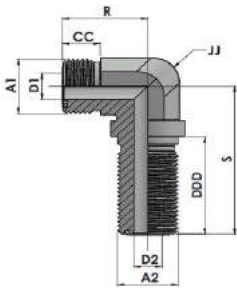

**XXHTFS2701-00-00 Series
MFS-MFS BULKHEAD 90° ELBOW**

Tube O.D.	A1 THREAD	A2 THREAD	R LENGTH	S LENGTH	CC LENGTH	DDD LENGTH	D1 DRILL	D2 DRILL	JJ Hex	Part Number	Weight	Torque N-m	Working pressure in Bar
1/4"	9/16"-18	9/16"-18	22.50	47.00	9.80	29.00	4.40	4.40	14.29	HTFS2701-04-04		14-16	413
3/8"	11/16"-18	11/16"-18	26.00	52.00	11.20	31.50	6.70	6.70	19.05	HTFS2701-06-06		24-27	413
1/2"	13/16"-16	13/16"-16	29.00	55.50	12.80	33.50	9.60	9.60	19.05	HTFS2701-08-08		43-47	413
5/8"	1"-14	1"-14	34.50	63.00	15.50	37.60	12.30	12.30	26.99	HTFS2701-10-10		60-68	413
3/4"	1-3/16"-12	1-3/16"-12	38.50	67.20	17.00	38.70	15.50	15.50	30.16	HTFS2701-12-12		90-95	413
1"	1-7/16"-12	1-7/16"-12	42.50	71.20	17.50	39.20	20.60	20.60	36.51	HTFS2701-16-16		125-135	413
1-1/4"	1-11/16"-12	1-11/16"-12	45.50	75.50	17.50	39.20	26.00	26.00	41.28	HTFS2701-20-20		170-190	275
1-1/2"	2"-12	2"-12	49.50	79.50	17.50	39.20	32.00	32.00	47.62	HTFS2701-24-24		200-225	275

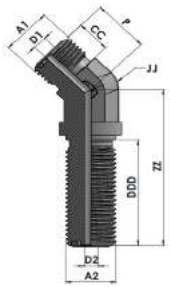

XXHTFS2702-00-00 Series
MFS-MFS BULKHEAD 45° ELBOW

Tube O.D.	A1 THREAD	A2 THREAD	P LENGTH	ZZ LENGTH	CC LENGTH	DDD LENGTH	D1 DRILL	D2 DRILL	JJ Hex	Part Number	Weight	Torque N-m	Working pressure in Bar
1/4"	9/16"-18	9/16"-18	16.00	44.00	9.80	29.00	4.40	4.40	14.29	HTFS2702-04-04		14-16	413
3/8"	11/16"-18	11/16"-18	18.80	48.50	11.20	31.50	6.70	6.70	19.05	HTFS2702-06-06		24-27	413
1/2"	13/16"-16	13/16"-16	20.30	51.00	12.80	33.50	9.60	9.60	19.05	HTFS2702-08-08		43-47	413
5/8"	1"-14	1"-14	23.40	56.60	15.50	37.60	12.30	12.30	26.99	HTFS2702-10-10		60-68	413
3/4"	1-3/16"-12	1-3/16"-12	25.90	60.70	17.00	38.70	15.50	15.50	30.16	HTFS2702-12-12		90-95	413
1"	1-7/16"-12	1-7/16"-12	30.00	65.20	17.50	39.20	20.60	20.60	36.51	HTFS2702-16-16		125-135	413
1-1/4"	1-11/16"-12	1-11/16"-12	32.00	67.00	17.50	39.20	26.00	26.00	41.28	HTFS2702-20-20		170-190	275
1-1/2"	2"-12	2"-12	36.80	67.00	17.50	39.20	32.00	32.00	47.62	HTFS2702-24-24		200-225	275

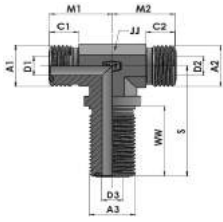

XXHTFS2703-00-00 Series

MFS-MFS-MFS-MFS BULKHEAD TEE

Tube O.D.	A1 THREAD	A2 THREAD	A3 THREAD	M1 LENGTH	M2 LENGTH	S LENGTH	C1 LENGTH	C2 LENGTH	WW LENGTH	D1 DRILL	D2 DRILL	D3 DRILL	JJ Hex	Part Number	Weight	Torque N-m	Working pressure in Bar
1/4"	9/16"-18	9/16"-18	9/16"-18	21.50	21.50	47.00	9.80	9.80	31.50	4.40	4.40	4.40	14.29	HTFS2703-04-04-04		14-16	413
3/8"	11/16"-18	11/16"-18	11/16"-18	25.00	25.00	52.00	11.20	11.20	34.00	6.70	6.70	6.70	19.05	HTFS2703-06-06-08		24-27	413
1/2"	13/16"-16	13/16"-16	13/16"-16	28.00	28.00	55.50	12.80	12.80	36.50	9.60	9.60	9.60	19.05	HTFS2703-08-08-08		43-47	413
5/8"	1"-14	1"-14	1"-14	33.30	33.30	63.00	15.50	15.50	40.60	12.30	12.30	12.30	26.99	HTFS2703-10-10-10		60-68	413
3/4"	1-3/16"-12	1-3/16"-12	1-3/16"-12	37.30	37.30	67.20	17.00	17.00	41.70	15.50	15.50	15.50	30.16	HTFS2703-12-12-12		90-95	413
1"	1-7/16"-12	1-7/16"-12	1-7/16"-12	41.70	41.70	71.20	17.50	17.50	42.20	20.60	20.60	20.60	36.51	HTFS2703-16-16-16		125-135	413
1-1/4"	1-11/16"-12	1-11/16"-12	1-11/16"-12	44.70	44.70	75.50	17.50	17.50	42.20	26.00	26.00	26.00	41.28	HTFS2703-20-20-20		170-190	275
1-1/2"	2"-12	2"-12	2"-12	48.80	48.80	79.50	17.50	17.50	42.20	32.00	32.00	32.00	47.62	HTFS2703-24-24-24		200-225	275

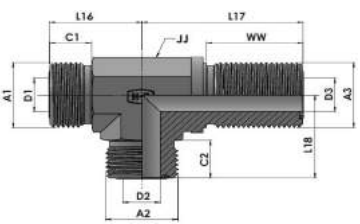

XXHTFS2704-00-00 Series
MFS-MFS-MFS-MFS BULKHEAD RUN TEE

Tube O.D.	A1 THREAD	A2 THREAD	A3 THREAD	L16 LENGTH	L17 LENGTH	L18 LENGTH	C1 LENGTH	C2 LENGTH	WW LENGTH	D1 DRILL	D2 DRILL	D3 DRILL	JJ Hex	Part Number	Weight	Torque N-m	Working pressure in Bar
1/4"	9/16"-18	9/16"-18	9/16"-18	22.50	47.00	44.00	9.80	9.80	31.50	4.40	4.40	4.40	14.29	HTFS2704-04-04-04		14-16	413
3/8"	11/16"-18	11/16"-18	11/16"-18	26.00	52.00	48.50	11.20	11.20	34.00	6.70	6.70	6.70	19.05	HTFS2704-06-06-08		24-27	413
1/2"	13/16"-16	13/16"-16	13/16"-16	29.00	55.50	51.00	12.80	12.80	36.50	9.60	9.60	9.60	19.05	HTFS2704-08-08-08		43-47	413
5/8"	1"-14	1"-14	1"-14	34.50	63.00	56.50	15.50	15.50	40.60	12.30	12.30	12.30	26.99	HTFS2704-10-10-10		60-68	413
3/4"	1-3/16"-12	1-3/16"-12	1-3/16"-12	38.50	67.00	60.50	17.00	17.00	41.70	15.50	15.50	15.50	30.16	HTFS2704-12-12-12		90-95	413
1"	1-7/16"-12	1-7/16"-12	1-7/16"-12	42.50	71.00	65.00	17.50	17.50	42.20	20.00	20.00	20.00	36.51	HTFS2704-16-16-16		125-135	413
1-1/4"	1-11/16"-12	1-11/16"-12	1-11/16"-12	45.50	75.50	67.00	17.50	17.50	42.20	26.00	26.00	26.00	41.28	HTFS2704-20-20-20		170-190	275

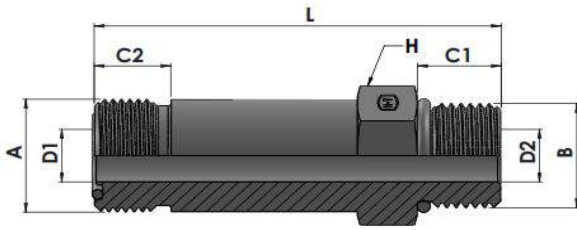

XXHTFS2764-00-00 Series

MFS BULKHEAD MORB STRAIGHT

Tube O.D.	A THREAD	B THREAD MORB	L LENGTH	C1 LENGTH	C2 LENGTH	D1 DRILL	D2 DRILL	H Hex	Part Number	Weight	Torque N-m	Working pressure in Bar
1/4"	9/16"-18	7/16"-20	52.83	9.80	9.80	4.40	4.40	20.64	HTFS2764-04-04	0.092	14-16	413
3/8"	11/16"-18	9/16"-18	57.15	11.20	11.20	6.70	6.70	25.40	HTFS2764-06-06	0.150	24-27	413
1/2"	13/16"-16	3/4"-16	62.48	12.80	12.80	9.60	9.60	28.58	HTFS2764-08-08	0.208	43-47	413
5/8"	1"-14	7/8"-14	69.60	15.50	15.50	12.30	12.30	33.34	HTFS2764-10-10	0.315	60-68	413
3/4"	1-3/16"-12	1-1/16"-12	73.41	17.00	17.00	15.50	15.50	38.10	HTFS2764-12-12	0.434	90-95	413
1"	1-7/16"-12	1-5/16"-12	73.66	17.50	17.50	20.60	20.60	44.45	HTFS2764-16-16	0.593	125-135	413
1-1/4"	1-11/16"-12	1-5/8"-12	73.66	17.50	17.50	26.00	26.00	50.80	HTFS2764-20-20	0.774	170-190	275
1-1/2"	2"-12	1-7/8"-12	73.66	17.50	17.50	32.00	32.00	60.33	HTFS2764-24-24	0.894	200-225	275

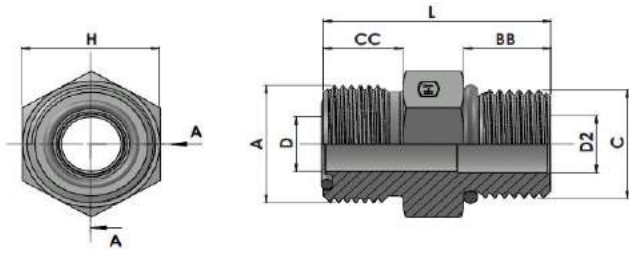

XXHTFS6400-00-00-O Series
MFS-MORB STRAIGHT

Tube O.D.	A THREAD	C THREAD	L LENGTH	CC LENGTH	BB LENGTH	D DRILL	D2 DRILL	H Hex	Part Number	Weight	Torque N-m	Working pressure in Bar
1/4"	9/16"-18	7/16"-20	28.80	9.80	11.00	4.40	4.40	15.88	HTFS6400-04-04-0	0.030	14-16	413
3/8"	11/16"-18	9/16"-18	31.90	11.20	12.00	6.70	7.50	19.05	HTFS6400-06-06-0	0.047	24-27	413
1/2"	13/16"-16	3/4"-16	36.60	12.80	14.00	9.60	9.90	22.22	HTFS6400-08-08-0	0.074	43-47	413
5/8"	1"-14	7/8"-14	43.10	15.50	16.00	12.30	12.30	26.99	HTFS6400-10-10-0	0.128	60-68	413
3/4"	1-3/16"-12	1-1/16"-12	48.60	17.50	18.50	15.50	15.50	31.75	HTFS6400-12-12-0	0.200	90-95	413
1"	1-7/16"-12	1-5/16"-12	50.30	17.50	18.50	20.60	21.40	38.10	HTFS6400-16-16-0	0.297	125-135	413
1-1/4"	1-11/16"-12	1-5/8"-12	52.30	17.50	18.50	26.00	27.40	44.45	HTFS6400-20-20-0	0.421	170-190	275
1-1/2"	2"-12	1-7/8"-12	54.10	17.50	18.50	32.00	33.30	53.98	HTFS6400-24-24-0	0.642	200-225	275

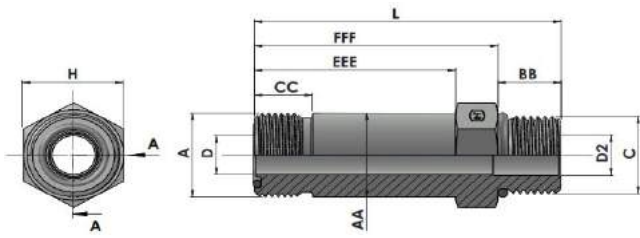

XXHTFS6400-L-00-00-O Series
MFS-MORB STRAIGHT LONG

Tube O.D.	A THREAD	C THREAD	L LENGTH	FFF LENGTH	EEE LENGTH	CC LENGTH	BB LENGTH	AA DIA	D DRILL	D2 DRILL	H Hex	Part Number	Weight	Torque N-m	Working pressure in Bar
1/4"	9/16"-18	7/16"-20	52.70	41.70	33.80	9.80	11.00	12.14	4.40	4.40	15.88	HTFS6400-L-04-04-0	0.054	14-16	413
3/8"	11/16"-18	9/16"-18	57.70	45.70	37.00	11.20	12.00	15.09	6.70	7.50	19.05	HTFS6400-L-06-06-0	0.085	24-27	413
1/2"	13/16"-16	3/4"-16	67.80	53.80	44.50	12.80	14.00	18.26	9.60	9.90	22.22	HTFS6400-L-08-08-0	0.136	43-47	413
5/8"	1"-14	7/8"-14	79.50	63.50	52.60	15.50	16.00	22.76	12.30	12.30	26.99	HTFS6400-L-10-10-0	0.236	60-68	413
3/4"	1-3/16"-12	1-1/16"-12	95.50	77.00	64.00	17.50	18.50	27.15	15.50	15.50	31.75	HTFS6400-L-12-12-0	0.392	90-95	413
1"	1-7/16"-12	1-5/16"-12	105.10	86.60	72.90	17.50	18.50	33.50	20.60	21.40	38.10	HTFS6400-L-16-16-0	0.621	125-135	413
1-1/4"	1-11/16"-12	1-5/8"-12	120.90	102.40	83.30	17.50	18.50	38.95	26.00	27.40	44.45	HTFS6400-L-20-20-0	0.973	170-190	275
1-1/2"	2"-12	1-7/8"-12	133.60	115.10	97.00	17.50	18.50	47.78	32.00	33.30	53.98	HTFS6400-L-24-24-0	1.585	200-225	275

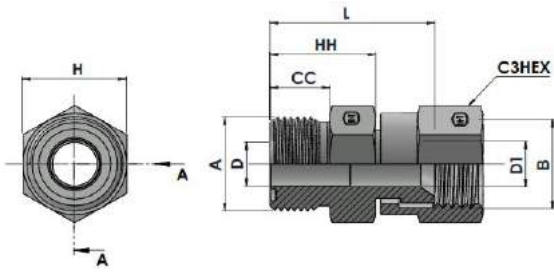

XXHTFS6402-00-00-O Series
MFS-MORB STRAIGHT LONG

Tube O.D.	A THREAD	B THREAD	L LENGTH	CC LENGTH	HH LENGTH	D DRILL	D1 LENGTH	H Hex	C3 Hex	Part Number	Weight	Torque N-m	Working pressure in Bar
1/4"	9/16"-18	7/16"-20	28.60	9.80	17.80	4.40	4.40	15.88	14.29	HTFS6402-04-04-0	0.044	14-16	413
3/8"	11/16"-18	9/16"-18	32.40	11.20	19.90	6.70	7.50	19.05	17.46	HTFS6402-06-06-0	0.072	24-27	413
1/2"	13/16"-16	3/4"-16	35.30	12.80	22.60	9.60	9.90	22.22	22.22	HTFS6402-08-08-0	0.115	43-47	413
5/8"	1"-14	7/8"-14	40.10	15.50	27.10	12.30	12.30	26.99	25.40	HTFS6402-10-10-0	0.185	60-68	413
3/4"	1-3/16"-12	1-1/16"-12	43.30	17.00	30.10	15.50	15.50	31.75	31.75	HTFS6402-12-12-0	0.284	90-95	413
1"	1-7/16"-12	1-5/16"-12	46.90	17.50	31.80	20.60	21.40	38.10	38.10	HTFS6402-16-16-0	0.297	125-135	413
1-1/4"	1-11/16"-12	1-5/8"-12		17.50	33.80	26.00	27.40	44.45	5.80	HTFS6402-20-20-0		170-190	275

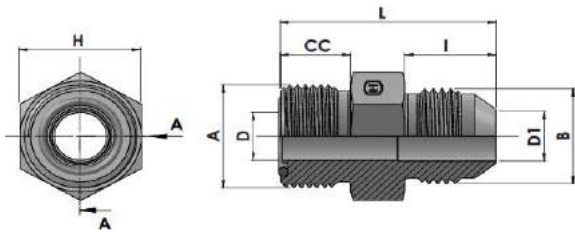

XXHTFS6403-00-00-O Series
MFS-MJ STRAIGHT

Tube O.D.	A THREAD	C THREAD	L LENGTH	CC LENGTH	I LENGTH	D DRILL	D1 DRILL	H Hex	Part Number	Weight	Torque N-m	Working pressure in Bar
1/4"	9/16"-18	7/16"-20	31.75	9.80	14.00	4.40	4.80	15.88	HTFS6403-04-04-0	0.033	14-16	413
3/8"	11/16"-18	9/16"-18	34.04	11.20	14.10	6.70	7.00	19.05	HTFS6403-06-06-0	0.050	24-27	413
1/2"	13/16"-16	3/4"-16	39.37	12.80	16.70	9.60	10.30	22.22	HTFS6403-08-08-0	0.079	43-47	413
5/8"	1"-14	7/8"-14	46.48	15.50	19.30	12.30	13.50	26.99	HTFS6403-10-10-0	0.138	60-68	413
3/4"	1-3/16"-12	1-1/16"-12	52.07	17.50	21.90	15.50	18.30	31.75	HTFS6403-12-12-0	0.214	90-95	413
1"	1-7/16"-12	1-5/16"-12	54.86	17.50	22.60	20.60	23.80	38.10	HTFS6403-16-16-0	0.324	125-135	413

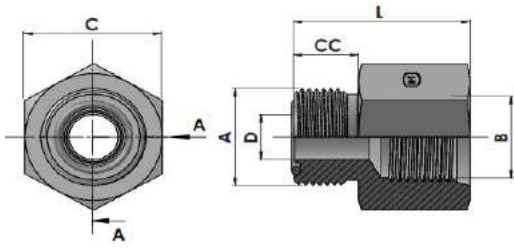

XXHTFS6410-00-00-O Series

FORB-MFS STRAIGHT

Tube O.D.	A THREAD	B THREAD	L LENGTH	CC LENGTH	D DRILL	C Hex	Part Number	Weight	Torque N-m	Working pressure in Bar
1/4"	9/16"-18	7/16"-20	27.69	9.80	4.40	17.46	HTFS6410-04-04-0	0.034	14-16	413
1/2"	13/16"-16	3/4"-16	34.54	12.80	9.60	26.97	HTFS6410-08-08-0	0.102	43-47	413
1"	1-3/16"-12	1-5/16"-12	45.47	17.50	15.50	41.28	HTFS6410-16-12-0	0.316	125-135	413
1"	1-7/16"-12	1-5/16"-12	45.72	17.50	20.60	41.28	HTFS6410-16-16-0	0.317	125-135	413
1-1/4"	1-11/16"-12	1-5/8"-12	47.24	17.50	26.00	53.97	HTFS6410-20-20-0	0.560	170-190	275
1-1/2"	2"-12	1-7/8"-12	47.50	17.50	32.00	63.50	HTFS6410-24-24-0	0.780	200-225	275

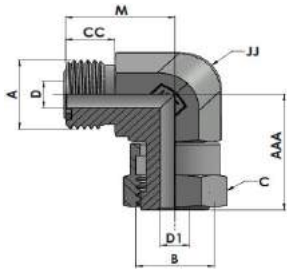

XXHTFS6500-00-00 Series

MFS-FFSS 90° ELBOW

Tube O.D.	A THREAD	B THREAD	M LENGTH	AAA LENGTH	CC LENGTH	D DRILL	D1 DRILL	JJ Hex	C Hex	Part Number	Weight	Torque N-m	Working pressure in Bar
1/4"	9/16"-18	9/16"-18	21.50	26.40	9.80	4.40	4.20	14.29	17.46	HTFS6500-04-04		14-16	413
3/8"	11/16"-18	11/16"-18	25.00	29.20	11.20	6.70	6.70	19.05	20.64	HTFS6500-06-06		24-27	413
1/2"	13/16"-16	13/16"-16	28.00	37.90	12.80	0.60	9.10	19.05	23.81	HTFS6500-08-08		43-47	413
5/8"	1"-14	1"-14	33.30	41.20	15.50	12.30	11.50	26.99	28.58	HTFS6500-10-10		60-68	413
3/4"	1-3/16"-12	1-3/16"-12	37.30	46.30	17.00	15.50	13.90	30.16	34.92	HTFS6500-12-12		90-95	413
1"	1-7/16"-12	1-7/16"-12	41.70	53.30	17.50	20.60	19.90	36.51	41.28	HTFS6500-16-16		125-135	413
1-1/4"	1-11/16"-12	1-11/16"-12	44.70	58.20	17.50	26.00	26.00	41.28	47.62	HTFS6500-20-20		170-190	275
1-1/2"	2"-12	2"-12	48.80	61.20	17.50	32.00	32.00	47.62	57.15	HTFS6500-24-24		200-225	275

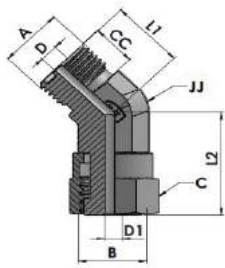

XXHTFS6502-00-00 Series
MFS-FFSS 45° ELBOW

Tube O.D.	A THREAD	B THREAD	L1 LENGTH	L2 LENGTH	CC LENGTH	D DRILL	D1 DRILL	JJ Hex	C Hex	Part Number	Weight	Torque N-m	Working pressure in Bar
1/4"	9/16"-18	9/16"-18	16.00	25.15	9.80	4.40	4.20	14.29	17.46	HTFS6502-04-04		14-16	413
3/8"	11/16"-18	11/16"-18	18.80	28.45	11.20	6.70	6.70	19.05	20.64	HTFS6502-06-06		24-27	413
1/2"	13/16"-16	13/16"-16	20.32	37.85	12.80	0.60	9.10	19.05	23.81	HTFS6502-08-08		43-47	413
5/8"	1"-14	1"-14	23.37	38.86	15.50	12.30	11.50	26.99	28.58	HTFS6502-10-10		60-68	413
3/4"	1-3/16"-12	1-3/16"-12	25.91	43.94	17.00	15.50	13.90	30.16	34.92	HTFS6502-12-12		90-95	413
1"	1-7/16"-12	1-7/16"-12	29.97	47.50	17.50	20.60	19.90	36.51	41.28	HTFS6502-16-16		125-135	413
1-1/4"	1-11/16"-12	1-11/16"-12	32.00	50.29	17.50	26.00	26.00	41.28	47.62	HTFS6502-20-20		170-190	275

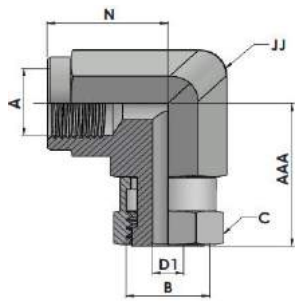

XXHTFS6503-00-00 Series
MFS-FFSS -90° ELBOW

Tube O.D.	A	THREAD	B	THREAD	N	AAA	D1	JJ	C	Part Number	Weight	Torque	Working
					LENGTH	LENGTH	DRILL	Hex	Hex			N-m	pressure
													in Bar
1/4"	1/4"	19BSPP-A	9/16"	-18	22.35	26.40	4.20	19.05	17.46	HTFS6503-04-04		14-16	413
3/8"	3/8"	19BSPP-A	11/16"	-18	25.91	29.20	6.70	22.22	20.64	HTFS6503-06-06		24-27	413

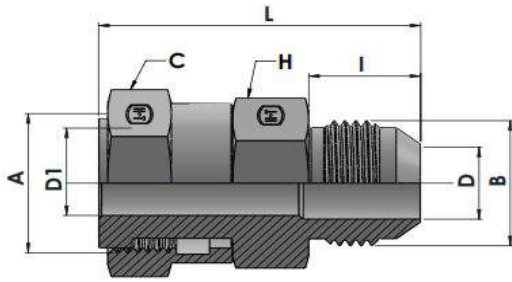

XXHTFS6504-00-00 Series
FFSS-MJ STRAIGHT

Tube O.D.	A THREAD	B THREAD	L LENGTH	I LENGTH	D1 DRILL	D DRILL	H Hex	C Hex	Part Number	Weight	Torque N-m	Working pressure in Bar
1/4"	9/16"-18	7/16"-20	40.13	14.00	4.20	4.80	15.88	17.46	HTFS6504-04-04	0.06	14-16	413
3/8"	11/16"-18	9/16"-18	42.32	14.10	6.70	7.00	19.05	20.64	HTFS6504-06-06	0.08	24-27	413
1/2"	13/16"-16	3/4"-16	51.99	16.70	9.10	10.30	22.22	23.81	HTFS6504-08-08	0.15	43-47	413
5/8"	1"-14	7/8"-14	57.10	19.30	11.50	13.50	26.99	28.58	HTFS6504-10-10	0.24	60-68	413
3/4"	1-3/16"-12	1-1/16"-12	63.09	21.90	13.90	18.30	31.75	34.92	HTFS6504-12-12	0.38	90-95	413
1"	1-7/16"-12	1-5/16"-12	72.16	22.60	19.90	23.80	38.10	41.28	HTFS6504-16-16	0.62	125-135	413
1-1/4"	1-11/16"-12	1-5/8"-12	73.36	24.30	26.00	31.70	47.63	47.63	HTFS6504-20-20	0.94	170-190	275

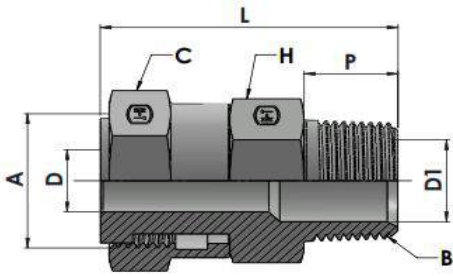

XXHTFS6505-00-00 Series
MP-FFSS STRAIGHT

Tube O.D.	A THREAD	B THREAD	L LENGTH	P LENGTH	D1 DRILL	D DRILL	H Hex	C Hex	Part Number	Weight	Torque N-m	Working pressure in Bar
3/8"	11/16"-18	1/4"-18NPTF	42.42	14.20	7.00	6.70	19.05	20.64	HTFS6505-04-06	0.06	14-16	413

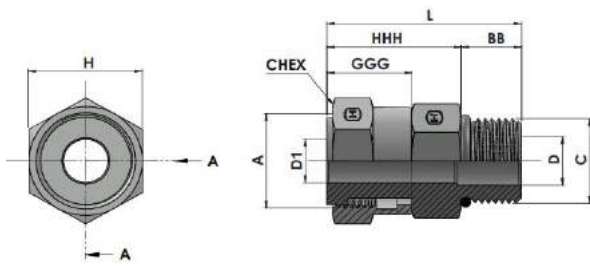

XXHTFS6540-00-00-O Series
MFS-MORB STRAIGHT LONG

Tube O.D.	A THREAD	C THREAD	L LENGTH	GGG LENGTH	HHH LENGTH	BB LENGTH	D DRILL	D1 LENGTH	H Hex	C Hex	Part Number	Weight	Torque N-m	Working pressure in Bar
1/4"	9/16"-18	7/16"-20	37.20	15.00	26.20	11.00	4.40	4.20	15.88	17.46	HTFS6540-04-04-0	0.056		
3/8"	11/16"-18	9/16"-18	40.20	17.30	28.20	12.00	6.70	6.70	19.05	20.64	HTFS6540-06-06-0	0.088		
1/2"	13/16"-16	9/16"-18	47.30	21.30	35.30	12.00	6.70	9.10	22.22	23.81	HTFS6540-08-06-0	0.142		
1/2"	13/16"-16	3/4"-16	49.30	21.30	35.30	14.00	9.60	9.10	22.22	23.81	HTFS6540-08-08-0	0.147		
5/8"	1"-14	7/8"-14	53.80	23.90	37.80	16.00	12.30	11.50	26.99	28.58	HTFS6540-10-10-0	0.237		
5/8"	1"-14	1-1/16"-12	56.30	23.90	37.80	18.50	15.50	11.50	31.75	28.58	HTFS6540-10-12-0	0.309		
3/4"	1-3/16"-12	1-1/16"-12	59.70	26.20	41.20	18.50	15.50	13.90	31.75	34.92	HTFS6540-12-12-0	0.374		
1"	1-7/16"-12	1-5/16"-12	67.50	28.20	49.00	18.50	20.60	19.90	38.10	41.28	HTFS6540-16-16-0	0.591		
1-1/4"	1-11/16"-12	1-5/8"-12	67.50	28.20	49.00	18.50	26.00	26.00	44.45	47.62	HTFS6540-20-20-0	0.799		
1-1/2"	2"-12	1-7/8"-12	67.50	28.20	49.00	18.50	32.00	32.00	53.98	57.15	HTFS6540-24-24-0	1.170		

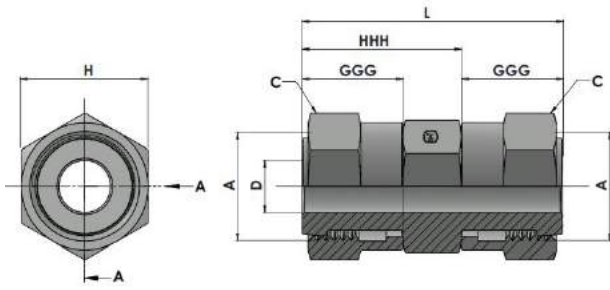

XXHTFS6565-00-00 Series
MFS-MORB STRAIGHT LONG

Tube O.D.	A THREAD	A THREAD	L LENGTH	GGG LENGTH	HHH LENGTH	D DRILL	H Hex	C Hex	Part Number	Weight	Torque N-m	Working pressure in Bar
1/4"	9/16"-18	9/16"-18	41.20	15.00	26.20	4.40	15.88	17.46	HTFS6565-04-04	0.078		
3/8"	11/16"-16	11/16"-16	45.50	17.30	28.20	6.70	19.05	20.64	HTFS6565-06-06	0.126		
1/2"	13/16"-16	13/16"-16	56.60	21.30	35.30	9.60	22.22	23.81	HTFS6565-08-08	0.209		
5/8"	1"-14	1"-14	61.70	23.90	37.80	12.30	26.99	28.58	HTFS6565-10-10	0.339		
3/4"	1-3/16"-12	1-3/16"-12	67.40	26.20	41.20	15.50	31.75	34.92	HTFS6565-12-12	0.534		
1"	1-7/16"-12	1-7/16"-12	77.20	28.20	49.00	20.60	38.10	41.28	HTFS6565-16-16	0.841		

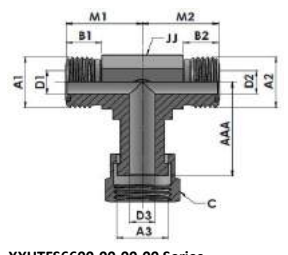

XXHTFS6600-00-00-00 Series
MFS-MFS-FFSS BRANCH TEE

Tube O.D.	A1 THREAD	A2 THREAD	A3 THREAD	M1 LENGTH	M2 LENGTH	AAA LENGTH	B1 LENGTH	B2 LENGTH	D1 DRILL	D2 DRILL	D3 DRILL	JJ Hex	C Hex	Part Number	Weight	Torque N-m	Working pressure in Bar
1/4"	9/16"-18	9/16"-18	9/16"-18	21.50	21.50	26.40	9.80	9.80	4.40	4.40	4.20	14.29	17.46	HTFS6600-04-04-04		14-16	413
3/8"	11/16"-18	11/16"-18	11/16"-18	25.00	25.00	29.20	11.20	11.20	6.70	6.70	6.70	19.05	20.64	HTFS6600-06-06-06		24-27	413
1/2"	13/16"-16	13/16"-16	13/16"-16	28.00	28.00	37.90	12.80	12.80	9.60	9.60	9.10	19.05	23.81	HTFS6600-08-08-08		43-47	413
5/8"	1"-14	1"-14	1"-14	33.30	33.30	41.20	15.50	15.50	12.30	12.30	11.50	26.99	28.58	HTFS6600-10-10-10		60-68	413
3/4"	1-3/16"-12	1-3/16"-12	1-3/16"-12	37.30	37.30	46.30	17.00	17.00	15.50	15.50	13.90	30.16	34.92	HTFS6600-12-12-12		90-95	413
1"	1-7/16"-12	1-7/16"-12	1-7/16"-12	41.70	41.70	53.30	17.50	17.50	20.60	20.60	19.90	36.51	41.28	HTFS6600-16-16-16		125-135	413
1-1/4"	1-11/16"-12	1-11/16"-12	1-11/16"-12	44.70	44.70	58.20	17.50	17.50	26.00	26.00	26.00	41.28	47.62	HTFS6600-20-20-20		170-190	275
1-1/2"	2"-12	2"-12	2"-12	48.80	48.80	61.20	17.50	17.50	32.00	32.00	32.00	47.62	57.15	HTFS6600-24-24-24		200-225	275

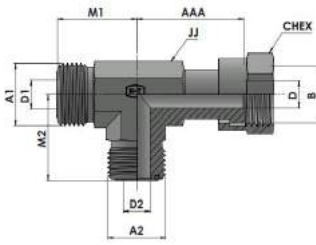

XXHTFS6602-00-00 Series

MFS-MORB STRAIGHT LONG

Tube O.D.	A1 THREAD	B THREAD	A 2 THREAD	M1 LENGTH	AAA LENGTH	M2 LENGTH	D1 DRILL	D DRILL	D2 DRILL	JJ Hex	C Hex	Part Number	Weight	Torque N-m	Working pressure in Bar
1/4"	9/16"-18	9/16"-18	9/16"-18	21.50	26.40	21.50	4.40	4.20	4.40	14.28	17.46	HTFS6602-04-04-04			
3/8"	11/16"-16	11/16"-16	9/16"-18	25.00	29.20	21.50	6.70	6.70	4.40	19.05	20.64	HTFS6602-06-06-04			
3/8"	11/16"-16	11/16"-16	11/16"-16	25.00	29.20	25.00	6.70	6.70	6.70	19.05	20.64	HTFS6602-06-06-06			
1/2"	11/16"-16	13/16"-16	11/16"-16	25.00	37.90	25.00	6.70	9.10	6.70	19.05	23.81	HTFS6602-06-08-06			
1/2"	11/16"-16	13/16"-16	13/16"-16	25.00	37.90	28.00	6.70	9.10	9.60	19.05	23.81	HTFS6602-06-08-08			
1/2"	13/16"-16	13/16"-16	11/16"-16	28.00	37.90	25.00	9.60	9.10	6.70	19.05	23.81	HTFS6602-08-08-06			
1/2"	13/16"-16	13/16"-16	13/16"-16	28.00	37.90	28.00	9.60	9.10	9.60	19.05	23.81	HTFS6602-08-08-08			
5/8"	1"-14	1"-14	1"-14	33.30	41.20	33.30	12.30	11.50	12.30	26.99	28.58	HTFS6602-10-10-10			
3/4"	1-3/16"-12	1-3/16"-12	1-3/16"-12	37.30	46.30	37.30	15.50	13.90	15.50	30.16	34.92	HTFS6602-12-12-12			
1"	1-7/16"-12	1-7/16"-12	1-7/16"-12	41.70	53.30	41.70	20.60	19.90	20.60	36.51	41.28	HTFS6602-16-16-16			
1-1/4"	1-11/16"-12	1-11/16"-12	1-11/16"-12	44.70	58.20	44.70	26.00	26.00	26.00	41.28	47.62	HTFS6602-20-20-20			
1-1/2"	2"-12	2"-12	2"-12	48.80	61.20	48.80	32.00	32.00	32.00	47.62	57.15	HTFS6602-24-24-24			

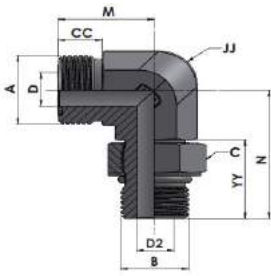

**XXHTFS6801-00-00 Series
MFS-MAORB 90° ELBOW**

Tube O.D.	A THREAD	B THREAD	M LENGTH	N LENGTH	CC LENGTH	YY LENGTH	D DRILL	D2 DRILL	JJ Hex	C Hex	Part Number	Weight	Torque N-m	Working pressure in Bar
1/4"	9/16"-18	7/16"-20	21.50	32.70	9.80	20.50	4.40	4.40	14.29	15.88	HTFS6801-04-04-NW0		14-16	413
3/8"	11/16"-18	9/16"-18	25.00	36.80	11.20	22.40	6.70	7.50	19.05	19.05	HTFS6801-06-06-NW0		24-27	413
1/2"	13/16"-16	3/4"-16	28.00	40.60	12.80	26.10	9.60	9.90	19.05	23.81	HTFS6801-08-08-NW0		43-47	413
5/8"	1"-14	7/8"-14	33.30	50.00	15.50	30.20	12.30	12.00	26.99	26.99	HTFS6801-10-10-NW0		60-68	413
3/4"	1-3/16"-12	1-1/16"-12	37.30	55.10	17.00	33.80	15.50	15.50	30.16	34.93	HTFS6801-12-12-NW0		90-95	413
1"	1-7/16"-12	1-5/16"-12	41.70	59.70	17.50	34.60	20.60	21.40	36.51	41.28	HTFS6801-16-16-NW0		125-135	413
1-1/4"	1-11/16"-12	1-5/8"-12	44.70	62.20	17.50	34.60	26.00	27.40	41.28	47.63	HTFS6801-20-20-NW0		170-190	275
1-1/2"	2"-12	1-7/8"-12	48.80	65.80	17.50	34.60	32.00	33.30	47.62	53.98	HTFS6801-24-24-NW0		200-225	275

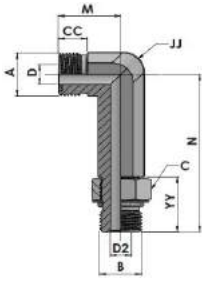

XXHTFS6801-L-00-00 Series
MFS-MAORB 90° ELBOW LONG

Tube O.D.	A THREAD	B THREAD	M LENGTH	N LENGTH	CC LENGTH	YY LENGTH	D DRILL	D2 DRILL	JJ Hex	C Hex	Part Number	Weight	Torque N-m	Working pressure in Bar
1/4"	9/16"-18	7/16"-20	21.50	56.60	9.80	20.50	4.40	4.40	14.29	15.88	HTFS6801-L-04-04-NW0		14-16	413
3/8"	11/16"-18	9/16"-18	25.00	66.30	11.20	22.40	6.70	7.50	19.05	19.05	HTFS6801-L-06-06-NW0		24-27	413
1/2"	13/16"-16	3/4"-16	28.00	74.90	12.80	26.10	9.60	9.90	19.05	23.81	HTFS6801-L-08-08-NW0		43-47	413
5/8"	1"-14	7/8"-14	33.30	89.20	15.50	30.20	12.30	12.00	26.99	26.99	HTFS6801-L-10-10-NW0		60-68	413
3/4"	1-3/16"-12	1-1/16"-12	37.30	100.80	17.00	33.80	15.50	15.50	30.16	34.93	HTFS6801-L-12-12-NW0		90-95	413
1"	1-7/16"-12	1-5/16"-12	41.70	114.60	17.50	34.60	20.60	21.40	36.51	41.28	HTFS6801-L-16-16-NW0		125-135	413
1-1/4"	1-11/16"-12	1-5/8"-12	44.70	126.50	17.50	34.60	26.00	27.40	41.28	47.63	HTFS6801-L-20-20-NW0		170-190	275
1-1/2"	2"-12	1-7/8"-12	48.80	139.20	17.50	34.60	32.00	33.30	47.62	53.98	HTFS6801-L-24-24-NW0		200-225	275

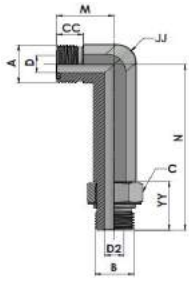

XXHTFS6801-LL-00-00 Series
MFS-MAORB 90° ELBOW X-LONG

Tube O.D.	A THREAD	B THREAD	M LENGTH	N LENGTH	CC LENGTH	YY LENGTH	D DRILL	D2 DRILL	JJ Hex	C Hex	Part Number	Weight	Torque N-m	Working pressure in Bar
1/2"	13/16"-16	3/4"-16	28.00	88.90	12.80	26.10	9.60	9.90	19.05	23.81	HTFS6801-LL-08-08-NW0		43-47	413
3/4"	1-3/16"-12	1-1/16"-12	37.30		17.00	33.80	15.50	15.50	30.16	34.93	HTFS6801-LL-12-12-NW0		90-95	413
1"	1-7/16"-12	1-5/16"-12	41.70	127.00	17.50	34.60	20.60	21.40	36.51	41.28	HTFS6801-LL-16-16-NW0		125-135	413

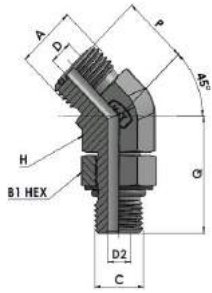

XXHTFS6802-00-00 NWO Series
MFS-MORB STRAIGHT LONG

Tube O.D.	A THREAD	C THREAD	P LENGTH	Q LENGTH	D DRILL	D2 DRILL	H Hex	B1 Hex	Part Number	Weight	Torque N-m	Working pressure in Bar
1/4"	9/16"-18	7/16"-20	16.00	30.00	4.40	4.40	14.28	15.88	HTFS6802-04-04-NWO			
1/4"	9/16"-18	9/16"-18	16.00	33.00	4.40	7.50	14.28	19.05	HTFS6802-04-06-NWO			
1/4"	9/16"-18	3/4"-16	16.00	36.30	4.40	9.90	19.05	23.81	HTFS6802-04-08-NWO			
3/8"	11/16"-16	7/16"-20	18.80	30.00	6.70	4.40	19.05	15.88	HTFS6802-06-04-NWO			
3/8"	11/16"-16	9/16"-18	18.80	33.00	6.70	7.50	19.05	19.05	HTFS6802-06-06-NWO			
3/8"	11/16"-16	3/4"-16	18.80	36.30	6.70	9.90	19.05	23.81	HTFS6802-06-08-NWO			
3/8"	11/16"-16	7/8"-14	18.80	44.70	6.70	12.30	26.99	26.99	HTFS6802-06-10-NWO			
1/2"	13/16"-16	9/16"-18	20.30	33.00	9.60	7.50	19.05	19.05	HTFS6802-08-06-NWO			
1/2"	13/16"-16	3/4"-16	20.30	36.30	9.60	9.90	19.05	23.81	HTFS6802-08-08-NWO			
1/2"	13/16"-16	7/8"-14	20.30	44.70	9.60	12.30	26.99	26.99	HTFS6802-08-10-NWO			
1/2"	13/16"-16	1-1/16"-12	20.30	50.00	9.60	15.50	30.16	34.93	HTFS6802-08-12-NWO			
5/8"	1"-14	3/4"-16	23.40	36.30	12.30	9.90	26.99	23.81	HTFS6802-10-08-NWO			
5/8"	1"-14	7/8"-14	23.40	44.70	12.30	12.30	26.99	26.99	HTFS6802-10-10-NWO			
5/8"	1"-14	1-1/16"-12	23.40	50.00	12.30	15.50	30.16	34.93	HTFS6802-10-12-NWO			
3/4"	1-3/16"-12	3/4"-16	25.90	36.30	15.50	9.90	30.16	23.81	HTFS6802-12-08-NWO			
3/4"	1-3/16"-12	7/8"-14	25.90	44.70	15.50	12.30	30.16	26.99	HTFS6802-12-10-NWO			
3/4"	1-3/16"-12	1-1/16"-12	25.90	50.00	15.50	15.50	30.16	34.93	HTFS6802-12-12-NWO			
3/4"	1-3/16"-12	1-5/16"-12	25.90	52.30	15.50	21.40	36.51	41.28	HTFS6802-12-16-NWO			
1"	1-7/16"-12	1-1/16"-12	30.00	50.00	20.60	15.50	36.51	34.93	HTFS6802-16-12-NWO			
1"	1-7/16"-12	1-5/16"-12	30.00	52.30	20.60	21.40	36.51	41.28	HTFS6802-16-16-NWO			
1"	1-7/16"-12	1-5/8"-12	30.00	53.60	20.60	27.40	41.28	47.63	HTFS6802-16-20-NWO			
1-1/4"	1-11/16"-12	1-5/16"-12	32.00	52.30	26.00	21.40	41.28	41.28	HTFS6802-20-16-NWO			
1-1/4"	1-11/16"-12	1-5/8"-12	32.00	53.60	26.00	27.40	41.28	47.63	HTFS6802-20-20-NWO			
1-1/2"	2"-12	1-7/8"-12	36.80	53.60	32.00	33.30	47.62	53.98	HTFS6802-24-24-NWO			

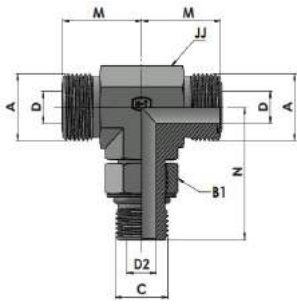

XXHTFS6803-00-00 NWO Series
MFS-MORB STRAIGHT LONG

Tube O.D.	A THREAD	C THREAD	M LENGTH	N LENGTH	D DRILL	D2 DRILL	JJ Hex	B1 Hex	Part Number	Weight	Torque N-m	Working pressure in Bar
1/4"	9/16"-18	7/16"-20	21.50	32.70	4.40	4.40	14.28	15.88	HTFS6803-04-04-04-NWO			
3/8"	11/16"-16	7/16"-20	25.00	32.70	6.70	4.40	19.05	15.88	HTFS6803-06-06-04-NWO			
3/8"	11/16"-16	9/16"-18	25.00	36.80	6.70	7.50	19.05	19.05	HTFS6803-06-06-06-NWO			
3/8"	11/16"-16	3/4"-16	25.00	40.60	6.70	9.90	19.05	23.81	HTFS6803-06-06-08-NWO			
1/2"	13/16"-16	3/4"-16	28.00	40.60	9.60	9.90	19.05	23.81	HTFS6803-08-08-08-NWO			
5/8"	1"-14	7/8"-14	33.30	50.00	12.30	12.30	26.99	26.99	HTFS6803-10-10-10-NWO			
3/4"	1-3/16"-12	1-1/16"-12	37.30	55.10	15.50	15.50	30.16	34.93	HTFS6803-12-12-12-NWO			
1"	1-7/16"-12	1-5/16"-12	41.70	59.70	20.60	21.40	36.51	41.28	HTFS6803-16-16-16-NWO			
1-1/4"	1-11/16"-12	1-5/8"-12	44.70	62.20	26.00	27.40	41.28	47.63	HTFS6803-20-20-20-NWO			
1-1/2"	2"-12	1-7/8"-12	36.80	65.80	32.00	33.30	47.62	53.98	HTFS6803-24-24-24-NWO			

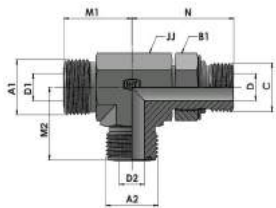

**XXHTFS6804-00-00-NWO Series
MFS-MORB STRAIGHT LONG**

Tube O.D.	A1 THREAD	C THREAD	A 2 THREAD	M1 LENGTH	N LENGTH	M2 LENGTH	D1 DRILL	D DRILL	D2 DRILL	JJ Hex	B1 Hex	Part Number	Weight	Torque N-m	Working pressure in Bar
1/4"	9/16"-18	7/16"-20	9/16"-18	21.50	32.70	21.50	4.40	4.40	4.40	14.28	15.88	HTFS6804-04-04-04-NWO			
1/4"	9/16"-18	9/16"-18	9/16"-18	21.50	36.80	21.50	4.40	7.50	4.40	19.05	19.05	HTFS6804-04-06-04-NWO			
3/8"	11/16"-16	7/16"-20	11/16"-18	25.00	32.70	25.00	6.70	4.40	6.70	19.05	15.88	HTFS6602-06-04-06-NWO			
3/8"	11/16"-16	9/16"-18	11/16"-16	25.00	36.80	25.00	6.70	7.50	6.70	19.05	19.05	HTFS6602-06-06-06-NWO			
3/8"	11/16"-16	3/4"-16	11/16"-16	25.00	40.60	25.00	6.70	9.90	6.70	19.05	23.81	HTFS6602-06-08-06-NWO			
1/2"	13/16"-16	9/16"-18	13/16"-16	28.00	36.80	28.00	9.60	7.50	9.60	19.05	19.05	HTFS6602-08-06-08-NWO			
1/2"	13/16"-16	3/4"-16	9/16"-18	28.00	40.60	21.50	9.60	9.90	4.40	19.05	23.81	HTFS6602-08-08-04-NWO			
1/2"	13/16"-16	3/4"-16	13/16"-16	28.00	40.60	28.00	9.60	9.90	9.60	19.05	23.81	HTFS6602-08-08-08-NWO			
1/2"	13/16"-16	7/8"-14	13/16"-16	28.00	50.00	28.00	9.60	12.30	9.60	26.99	26.99	HTFS6602-08-10-08-NWO			
1/2"	13/16"-16	1-1/16"-12	9/16"-18	28.00	55.10	21.50	9.60	15.50	4.40	30.16	34.93	HTFS6602-08-12-04-NWO			
1/2"	13/16"-16	1-1/16"-12	13/16"-16	28.00	55.10	28.00	9.60	15.50	9.60	30.16	34.93	HTFS6602-08-12-08-NWO			
5/8"	1"-14	7/8"-14	11/16"-16	33.30	50.00	25.00	12.30	12.30	6.70	26.99	26.99	HTFS6602-10-10-06-NWO			
5/8"	1"-14	7/8"-14	1"-14	33.30	50.00	33.30	12.30	12.30	12.30	26.99	26.99	HTFS6602-10-10-10-NWO			
5/8"	1"-14	1-1/16"-12	1"-14	33.30	55.10	33.30	12.30	15.50	12.30	30.16	34.93	HTFS6602-10-12-10-NWO			
3/4"	1-3/16"-12	3/4"-16	13/16"-16	37.30	40.60	28.00	15.50	9.90	9.60	30.16	23.81	HTFS6602-12-08-08-NWO			
3/4"	1-3/16"-12	1-1/16"-12	13/16"-16	37.30	55.10	28.00	15.50	15.50	9.60	30.16	34.93	HTFS6602-12-12-08-NWO			
3/4"	1-3/16"-12	1-1/16"-12	1-3/16"-12	37.30	55.10	37.30	15.50	15.50	15.50	30.16	34.93	HTFS6602-12-12-12-NWO			
3/4"	1-3/16"-12	1-1/16"-12	1-7/16"-12	37.30	55.10	41.70	15.50	15.50	20.60	36.51	34.93	HTFS6602-12-12-16-NWO			
1"	1-7/16"-12	1-1/16"-12	1-3/16"-12	41.70	55.10	37.30	20.60	15.50	15.50	36.51	34.93	HTFS6602-16-12-12-NWO			
1"	1-7/16"-12	1-5/16"-12	1-7/16"-12	41.70	59.70	41.70	20.60	21.40	20.60	36.51	41.28	HTFS6602-16-16-16-NWO			
1"	1-7/16"-12	1-7/8"-12	1-7/16"-12	41.70	65.80	41.70	20.60	33.30	20.60	42.62	53.98	HTFS6602-16-24-16-NWO			
1-1/4"	1-11/16"-12	1-5/8"-12	1-11/16"-12	44.70	62.20	44.70	26.00	27.40	26.00	41.28	47.63	HTFS6602-20-20-20-NWO			
1-1/2"	2"-12	1-7/8"-12	2"-12	48.80	65.80	48.80	32.00	33.30	32.00	47.62	53.98	HTFS6602-24-24-24-NWO			

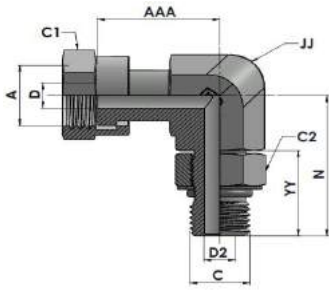

**XXHTFS6809-00-00 Series
FFSS-MAORB 90° ELBOW**

Tube O.D.	A THREAD	C THREAD	N LENGTH	AAA LENGTH	YY LENGTH	D DRILL	D2 DRILL	JJ Hex	C1 Hex	C2 Hex	Part Number	Weight	Torque N-m	Working pressure in Bar
1/4"	9/16"-18	7/16"-20	32.70	26.40	20.50	4.20	4.40	14.29	17.46	15.88	HTFS6809-04-04-NW0		14-16	413
3/8"	11/16"-18	9/16"-18	36.80	29.20	22.40	6.70	7.50	19.05	20.64	19.05	HTFS6809-06-06-NW0		24-27	413
1/2"	13/16"-16	3/4"-16	40.60	37.90	26.10	9.10	9.90	19.05	23.81	23.81	HTFS6809-08-08-NW0		43-47	413
5/8"	1"-14	7/8"-14	50.00	41.20	30.20	11.50	12.00	26.99	28.58	26.99	HTFS6809-10-10-NW0		60-68	413
3/4"	1-3/16"-12	1-1/16"-12	55.10	46.30	33.80	13.90	15.50	30.16	34.92	34.93	HTFS6809-12-12-NW0		90-95	413
1"	1-7/16"-12	1-5/16"-12	59.70	53.30	34.60	19.90	21.40	36.51	41.28	41.28	HTFS6809-16-16-NW0		125-135	413
1-1/4"	1-11/16"-12	1-5/8"-12	62.20	58.20	34.60	26.00	27.40	41.28	47.62	47.63	HTFS6809-20-20-NW0		170-190	275
1-1/2"	2"-12	1-7/8"-12	65.80	61.20	34.60	32.00	33.30	47.62	57.15	53.98	HTFS6809-24-24-NW0		200-225	275

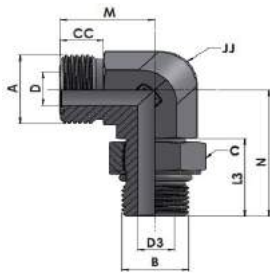

**XXHTFS7202-00-00 Series
MFS-MBSPP 90° ELBOW**

Tube O.D.	A THREAD	B THREAD	M LENGTH	N LENGTH	CC LENGTH	L3 LENGTH	D DRILL	D3 DRILL	JJ Hex	C Hex	Part Number	Weight	Torque N-m	Working pressure in Bar
1/4"	9/16"-18	1/4"-19	23.50	36.00	9.80	20.00	4.40	7.50	19.00	19.00	HTFS7202-04-04-NW0		50-55	
3/8"	11/16"-18	3/8"-19	26.50	38.00	11.20	20.00	6.70	9.90	19.00	22.00	HTFS7202-06-06-NW0		80-88	
1/2"	13/16"-16	1/2"-14	30.80	48.50	12.80	26.10	9.60	12.30	27.00	27.00	HTFS7202-08-08-NW0		105-115.5	
3/4"	1-3/16"-12	3/4"-14	37.30	51.50	17.00	26.10	15.50	15.50	30.00	36.00	HTFS7202-12-12-NW0		220-242	
1"	1-7/16"-12	1"-11	41.70	58.50	17.50	30.00	20.60	21.50	36.00	41.00	HTFS7202-16-16-NW0		370-407	
1-1/4"	1-11/16"-12	1-1/4"-11	44.70	62.20	17.50	30.00	26.00	27.50	41.00	50.00	HTFS7202-20-20-NW0		500-550	
1-1/2"	2"-12	1-1/2"-11	48.80	65.80	17.50	30.00	32.00	33.00	50.00	55.00	HTFS7202-24-24-NW0		600-660	

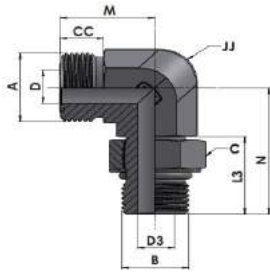

**XXHTFS7205-00-00 Series
MFS-MMAORB 90° ELBOW**

Tube O.D.	A THREAD	B THREAD	M LENGTH	N LENGTH	CC LENGTH	L3 LENGTH	D DRILL	D3 DRILL	JJ Hex	C Hex	Part Number	Weight	Torque N-m	Working pressure in Bar
1/4"	9/16"-18	M12X1.5-6g	21.50	33.00	9.80	21.00	4.40	4.00	14.00	17.00	HTFS7205-04-12-NW0		35-38.5	
1/4"	9/16"-18	M14X1.5-6g	23.50	35.50	9.80	21.00	4.40	6.00	17.00	19.00	HTFS7205-04-14-NW0		45-49.50	
3/8"	11/16"-18	M10X1-6g	25.00	32.00	11.20	18.00	6.70	3.00	17.00	14.00	HTFS7205-06-10-NW0		20-22	
3/8"	11/16"-18	M12X1.5-6g	25.00	35.50	11.20	21.00	6.70	4.00	17.00	17.00	HTFS7205-06-12-NW0		35-38.5	
3/8"	11/16"-18	M14X1.5-6g	25.00	35.50	11.20	21.00	6.70	6.00	17.00	19.00	HTFS7205-06-14-NW0		45-49.50	
3/8"	11/16"-18	M16X1.5-6g	25.00	37.50	11.20	23.00	6.70	7.00	17.00	22.00	HTFS7205-06-16-NW0		55-60.50	
3/8"	11/16"-18	M18X1.5-6g	25.00	41.00	11.20	26.00	6.70	9.00	19.00	24.00	HTFS7205-06-18-NW0		70-77	
1/2"	13/16"-16	M14X1.5-6g	28.00	36.00	12.80	21.00	9.60	6.00	19.00	19.00	HTFS7205-08-14-NW0		45-49.50	
1/2"	13/16"-16	M16X1.5-6g	28.00	38.00	12.80	23.00	9.60	7.00	19.00	22.00	HTFS7205-08-16-NW0		55-82.50	
1/2"	13/16"-16	M18X1.5-6g	28.00	41.00	12.80	26.00	9.60	9.00	19.00	24.00	HTFS7205-08-18-NW0		70-77	
5/8"	1"-14UNS	M18X1.5-6g	33.30	47.50	17.50	26.00	12.30	9.00	24.00	24.00	HTFS7205-10-18-NW0		70-77	
5/8"	1"-14UNS	M22X1.5-6g	3.30	49.00	17.50	27.50	12.30	12.00	24.00	27.00	HTFS7205-10-22-NW0		100-110	
5/8"	1"-14UNS	M27X2.0-6g	35.80	55.50	17.50	33.50	12.30	15.00	27.00	32.00	HTFS7205-10-27-NW0		170-187	
3/4"	1-3/16"-12	M22X1.5-6g	37.30	49.00	17.50	27.50	15.50	12.00	27.00	27.00	HTFS7205-10-22-NW0		100-110	
3/4"	1-3/16"-12	M27X2.0-6g	37.30	55.50	17.50	33.50	15.50	15.00	27.00	32.00	HTFS7205-12-27-NW0		170-187	
1"	1-7/16"-12	M33X2.0-6g	41.70	59.50	17.50	33.50	20.60	20.00	36.00	41.00	HTFS7205-16-33-NW0		310-341	
1-1/4"	1-11/16"-12	M33X2.0-6g	44.70	62.00	17.50	33.50	26.00	20.00	41.00	41.00	HTFS7205-20-33-NW0		310-341	
1-1/4"	1-11/16"-12	M42X2.0-6g	44.70	63.00	17.50	34.50	26.00	26.00	41.00	50.00	HTFS7205-20-42-NW0		330-363	
1-1/2"	2"-12	M48X2.0-6g	48.80	71.50	17.50	38.00	32.00	32.00	50.00	55.00	HTFS7205-24-48-NW0		420-462	

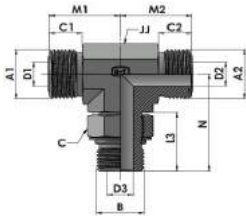

XXHTFS7210-00-00-00 Series
MFS-MFS-MMAORB TEE

Tube O.D.	A1 THREAD	A2 THREAD	B THREAD	M1 LENGTH	M2 LENGTH	N LENGTH	C1 LENGTH	C2 LENGTH	L3 LENGTH	D1 DRILL	D2 DRILL	D3 DRILL	JJ Hex	C Hex	Part Number	Weight	Torque N-m	Working pressure in Bar
1/4"	9/16"-18	9/16"-18	M12X1.5-6g	21.50	21.50	33.00	9.80	9.80	21.00	4.40	4.40	4.00	14.00	17.00	HTFS7210-04-04-12-NW0		35-38.5	
1/4"	9/16"-18	9/16"-18	M14X1.5-6g	23.50	23.50	35.50	9.80	9.80	21.00	4.40	4.40	6.00	17.00	19.00	HTFS7210-04-04-14-NW0		45-49.50	
3/8"	11/16"-18	11/16"-18	M14X1.5-6g	25.00	25.00	35.50	11.20	11.20	21.00	6.70	6.70	6.00	17.00	19.00	HTFS7210-06-06-14-NW0		45-49.50	
3/8"	11/16"-18	11/16"-18	M16X1.5-6g	25.00	25.00	37.50	11.20	11.20	23.00	6.70	6.70	7.00	17.00	22.00	HTFS7210-06-06-16-NW0		55-60.50	
1/2"	13/16"-16	13/16"-16	M14X1.5-6g	28.00	28.00	36.00	12.80	12.80	21.00	9.60	9.60	6.00	19.00	19.00	HTFS7210-08-08-14-NW0		45-49.50	
1/2"	13/16"-16	13/16"-16	M18X1.5-6g	28.00	28.00	41.00	12.80	12.80	26.00	9.60	9.60	9.00	19.00	24.00	HTFS7210-08-08-18-NW0		70-77	
1/2"	13/16"-16	13/16"-16	M22X1.5-6g	31.00	31.00	49.00	12.80	12.80	27.50	9.60	9.60	12.00	24.00	27.00	HTFS7210-08-08-22-NW0		100-110	
5/8"	1"-14UNS	1"-14UNS	M22X1.5-6g	33.50	33.50	49.00	17.50	17.50	27.50	12.30	12.30	12.00	24.00	27.00	HTFS7210-10-10-22-NW0		100-110	
3/4"	1-3/16"-12	1-3/16"-12	M27X2.0-6g	37.50	37.50	55.50	17.50	17.50	33.50	15.50	15.50	15.00	27.00	32.00	HTFS7210-12-12-27-NW0		170-187	
1"	1-7/16"-12	1-7/16"-12	M33X2.0-6g	41.50	41.50	59.50	17.50	17.50	33.50	20.60	20.60	20.00	36.00	41.00	HTFS7210-16-16-33-NW0		310-341	
1-1/4"	1-11/16"-12	1-11/16"-12	M42X2.0-6g	44.50	44.50	63.00	17.50	17.50	34.50	26.00	26.00	26.00	41.00	50.00	HTFS7210-20-20-42-NW0		330-363	
1-1/2"	2"-12	2"-12	M48X2.0-6g	49.00	49.00	71.50	17.50	17.50	38.00	32.00	32.00	32.00	50.00	55.00	HTFS7210-24-24-48-NW0		420-462	

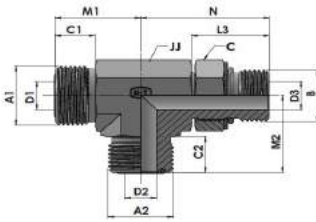

XXHTFS7215-00-00 Series
MFS-MMAORB-MFS TEE

Tube O.D.	A1 THREAD	A2 THREAD	B THREAD	M1 LENGTH	M2 LENGTH	N LENGTH	C1 LENGTH	C2 LENGTH	L3 LENGTH	D1 DRILL	D2 DRILL	D3 DRILL	JJ Hex	C Hex	Part Number	Weight	Torque N-m	Working pressure in Bar
1/4"	9/16"-18	9/16"-18	M12X1.5-6g	21.50	21.50	33.00	9.80	9.80	21.00	4.40	4.40	4.00	14.00	17.00	HTFS7215-04-12-04-NW0		35-38.5	
1/4"	9/16"-18	9/16"-18	M14X1.5-6g	23.50	23.50	35.50	9.80	9.80	21.00	4.40	4.40	6.00	17.00	19.00	HTFS7215-04-14-04-NW0		45-49.50	
3/8"	11/16"-18	11/16"-18	M14X1.5-6g	25.00	25.00	35.50	11.20	11.20	21.00	6.70	6.70	6.00	17.00	19.00	HTFS7215-06-14-06-NW0		45-49.50	
3/8"	11/16"-18	11/16"-18	M16X1.5-6g	25.00	25.00	37.50	11.20	11.20	23.00	6.70	6.70	7.00	17.00	22.00	HTFS7215-06-16-06-NW0		55-60.50	
1/2"	13/16"-16	13/16"-16	M14X1.5-6g	28.00	28.00	36.00	12.80	12.80	21.00	9.60	9.60	6.00	19.00	19.00	HTFS7215-08-14-08-NW0		45-49.50	
1/2"	13/16"-16	13/16"-16	M18X1.5-6g	28.00	28.00	41.00	12.80	12.80	26.00	9.60	9.60	9.00	19.00	24.00	HTFS7215-08-18-08-NW0		70-77	
1/2"	13/16"-16	13/16"-16	M22X1.5-6g	31.00	31.00	49.00	12.80	12.80	27.50	9.60	9.60	12.00	24.00	27.00	HTFS7215-08-22-08-NW0		100-110	
5/8"	1"-14UNS	1"-14UNS	M18X1.5-6g	33.50	33.50	47.50	17.50	17.50	26.00	12.30	12.30	9.00	24.00	24.00	HTFS7215-10-18-10-NW0		70-77	
5/8"	1"-14UNS	1"-14UNS	M22X1.5-6g	33.50	33.50	49.00	17.50	17.50	27.50	12.30	12.30	12.00	24.00	27.00	HTFS7215-10-22-10-NW0		100-110	
3/4"	1-3/16"-12	1-3/16"-12	M27X2.0-6g	37.50	37.50	55.50	17.50	17.50	33.50	15.50	15.50	15.00	27.00	32.00	HTFS7215-12-27-12-NW0		170-187	
1"	1-7/16"-12	1-7/16"-12	M33X2.0-6g	41.50	41.50	59.50	17.50	17.50	33.50	20.60	20.60	20.00	36.00	41.00	HTFS7215-16-33-16-NW0		310-341	
1-1/4"	1-11/16"-12	1-11/16"-12	M42X2.0-6g	44.50	44.50	63.00	17.50	17.50	34.50	26.00	26.00	26.00	41.00	50.00	HTFS7215-20-42-20-NW0		330-363	
1-1/2"	2"-12	2"-12	M48X2.0-6g	49.00	49.00	71.50	17.50	17.50	38.00	32.00	32.00	32.00	50.00	55.00	HTFS7215-24-48-24-NW0		420-462	

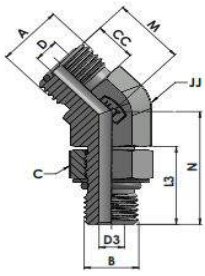

XXHTFS7300-00-00 Series
MFS-MMAORB 45° ELBOW

Tube O.D.	A THREAD	B THREAD	M LENGTH	N LENGTH	CC LENGTH	L3 LENGTH	D DRILL	D3 DRILL	JJ Hex	C Hex	Part Number	Weight	Torque N-m	Working pressure in Bar
1/4"	9/16"-18	M12X1.5-6g	16.00	30.00	9.80	21.00	4.40	4.00	14.00	17.00	HTFS7300-04-12-NW0		35-38.5	
1/4"	9/16"-18	M14X1.5-6g	17.50	31.50	9.80	21.00	4.40	6.00	17.00	19.00	HTFS7300-04-14-NW0		45-49.50	
3/8"	11/16"-18	M16X1.5-6g	19.00	33.50	11.20	23.00	6.70	7.00	17.00	22.00	HTFS7300-06-16-NW0		55-60.50	
1/2"	13/16"-16	M14X1.5-6g	20.50	32.00	12.80	21.00	9.60	6.00	19.00	19.00	HTFS7300-08-14-NW0		45-49.50	
1/2"	13/16"-16	M18X1.5-6g	20.50	37.00	12.80	26.00	9.60	9.00	19.00	24.00	HTFS7300-08-18-NW0		70-77	
5/8"	1"-14UNS	M22X1.5-6g	23.50	44.00	17.50	27.50	12.30	12.00	24.00	27.00	HTFS7300-10-22-NW0		100-110	
3/4"	1-3/16"-12	M27X2.0-6g	26.00	50.50	17.50	33.50	15.50	15.00	27.00	32.00	HTFS7300-12-27-NW0		170-187	
1"	1-7/16"-12	M33X2.0-6g	30.00	52.50	17.50	33.50	20.60	20.00	36.00	41.00	HTFS7300-16-33-NW0		310-341	
1-1/4"	1-11/16"-12	M42X2.0-6g	32.00	54.00	17.50	34.50	26.00	26.00	41.00	50.00	HTFS7300-20-42-NW0		330-363	
1-1/2"	2"-12	M48X2.0-6g	37.00	56.50	17.50	38.00	32.00	32.00	50.00	55.00	HTFS7300-24-48-NW0		420-462	

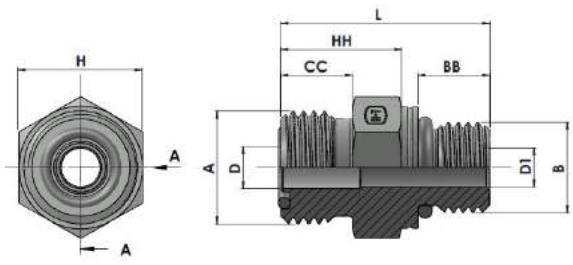

XXHTFS7640-00-00-NWO Series
MFS-MORB STRAIGHT LONG

Tube O.D.	A THREAD	B THREAD	L LENGTH	CC LENGTH	HH LENGTH	BB LENGTH	D DRILL	D1 DRILL	H Hex	Part Number	Weight	Torque N-m	Working pressure in Bar
6	9/16"-18	M10X1.0	28.90	9.80	17.80	9.50	4.40	3.00	17.00	HTFS7640-04-10-O	0.034		
6	9/16"-18	M12X1.5	31.30	9.80	17.80	11.00	4.40	4.00	17.00	HTFS7640-04-12-O	0.037		
6	9/16"-18	M14X1.5	31.30	9.80	17.80	11.00	4.40	6.00	19.00	HTFS7640-04-14-O	0.046		
10	11/16"-16	M12X1.5	33.40	11.20	19.90	11.00	6.70	4.00	19.00	HTFS7640-06-12-O	0.049		
10	11/16"-16	M14X1.5	33.40	11.20	19.90	11.00	6.70	6.00	19.00	HTFS7640-06-14-O	0.049		
10	11/16"-16	M16X1.5	34.90	11.20	19.90	12.50	6.70	7.00	22.00	HTFS7640-06-16-O	0.068		
10	11/16"-16	M18X1.5	36.40	11.20	19.90	14.00	6.70	9.00	24.00	HTFS7640-06-18-O	0.085		
10	11/16"-16	M22X1.5	37.40	11.20	19.90	15.00	6.70	12.00	27.00	HTFS7640-06-22-O	0.111		
12	13/16"-16	M14X1.5	36.10	12.80	22.60	11.00	9.60	6.00	22.00	HTFS7640-08-14-O	0.072		
12	13/16"-16	M16X1.5	37.60	12.80	22.60	12.50	9.60	7.00	22.00	HTFS7640-08-16-O	0.074		
12	13/16"-16	M18X1.5	39.10	12.80	22.60	14.00	9.60	9.00	24.00	HTFS7640-08-18-O	0.092		
12	13/16"-16	M22X1.5	40.10	12.80	22.60	15.00	9.60	12.00	27.00	HTFS7640-08-22-O	0.110		
12	13/16"-16	M26X1.5		12.80	22.60		9.60		32.00	HTFS7640-08-26-O			
12	13/16"-16	M27X2.0	43.60	12.80	22.60	18.50	9.60	15.00	32.00	HTFS7640-08-27-O	0.181		
12	13/16"-16	M33X2.0	44.10	12.80	22.60	18.50	9.60	20.00	41.00	HTFS7640-08-33-O	0.302		
16	1"-14	M18X1.5	43.60	15.50	27.10	14.00	12.30	9.00	27.00	HTFS7640-10-18-O	0.129		
16	1"-14	M22X1.5	44.60	15.50	27.10	15.00	12.30	12.00	27.00	HTFS7640-10-22-O	0.132		
16	1"-14	M27X2.0	48.10	15.50	27.10	18.50	12.30	15.00	32.00	HTFS7640-10-27-O	0.200		
16	1"-14	M33X2.0	48.60	15.50	27.10	18.50	12.30	20.00	41.00	HTFS7640-10-33-O	0.330		
20	1-3/16"-12	M22X1.5	47.60	17.00	30.10	15.00	15.50	12.00	32.00	HTFS7640-12-22-O	0.198		
20	1-3/16"-12	M27X2.0	51.10	17.00	30.10	18.50	15.50	15.00	32.00	HTFS7640-12-27-O	0.213		
20	1-3/16"-12	M33X2.0	51.60	17.00	30.10	18.50	15.50	20.00	41.00	HTFS7640-12-33-O	0.360		
25	1-7/16"-12	M33X2.0	53.30	17.50	31.80	18.50	20.60	20.00	41.00	HTFS7640-16-33-O	0.360		
30	1-11/16"-12	M38X2.0		17.50	33.80		26.00		50.00	HTFS7640-20-38-O			
30	1-11/16"-12	M42X2.0	55.80	17.50	33.80	19.00	26.00	26.00	50.00	HTFS7640-20-42-O	0.568		

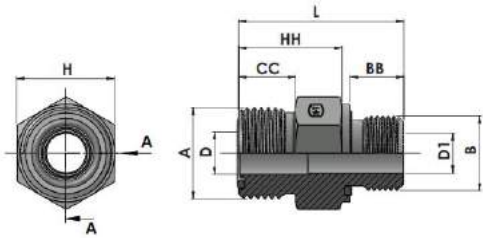

XXHTFS7701-00-00-NWO Series

MFS-MORB STRAIGHT LONG

Tube O.D.	A THREAD	B THREAD	L LENGTH	CC LENGTH	HH LENGTH	BB LENGTH	D DRILL	D1 DRILL	H Hex	Part Number	Weight	Torque N-m	Working pressure in Bar
1/4"	9/16"-18	M10X1.0	27.30	9.80	17.80	8.00	4.40	4.00	17.00	HTFS7701-04-10	0.032		
1/4"	9/16"-18	M12X1.5	31.80	9.80	17.80	12.00	4.40	6.00	19.00	HTFS7701-04-12	0.046		
1/4"	9/16"-18	M14X1.5	31.80	9.80	17.80	12.00	4.40	7.00	19.00	HTFS7701-04-14	0.046		
3/8"	11/16"-16	M18X1.5	34.40	11.20	19.90	12.00	6.70	11.00	27.00	HTFS7701-06-18	0.102		
5/8"	1"-14	M18X1.5	41.60	15.50	27.10	12.00	12.30	11.00	27.00	HTFS7701-10-18	0.123		
5/8"	1"-14	M22X1.5	44.10	15.50	27.10	14.00	12.30	14.00	27.00	HTFS7701-10-22	0.130		
1"	1-7/16"-12	M33X2.0	52.80	17.50	31.80	18.00	20.60	23.00	41.00	HTFS7701-16-33	0.360		